

PCI-1712/1712L User's manual

1 MS/s, 12-bit, 16-ch High-Speed Multifunction Card

Unpacking

The PCI-1712/1712L package should contain the following items:

- PCI-1712/1712L card
- Companion CD-ROM disc
- User's Manual
- Quick Start

Driver Installation

Step 1: Insert the companion disc into your CD-ROM drive.

Step 2: The *Setup Program* will be launched automatically, and you'll see the following *Setup Screen*.

Select the **DLL Drivers** installation option. (If *autoplay* is not enabled, please use



Windows Explorer or *Windows Run* command to execute *setup.exe* on CD-ROM).

Step 3: Select the **Windows 95/98** or **Windows NT** option according to your operating system.

Step 4: Follow the installation instructions step by step to complete your DLL driver setup.

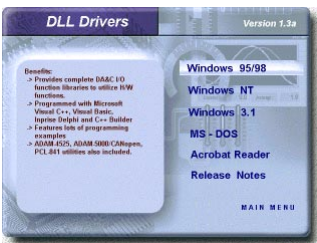

Hardware Installation

- Step 1:** Turn off your computer and unplug the power cord and cables
- Step 2:** Remove the cover of your computer
- Step 3:** Remove the slot cover on the back panel of your computer
- Step 4:** Touch the metal part of your computer chassis to discharge static electricity on your body
- Step 5:** Insert the PCI-1712/1712L card into a PCI slot. Hold the card only by its edges and carefully align it with the slot, then insert the card firmly into place. Use of excessive force must be avoided otherwise the card might be damaged.
- Step 6:** Fasten the bracket of the PCI card on the back panel rail of the computer with screws
- Step 7:** Connect appropriate accessories (68-pin cable, wiring terminals, etc., if necessary) to the PCI card.
- Step 8:** Replace the cover of your computer chassis. Re-connect the cables you removed in step 2.
- Step 9:** Plug in the power cord and turn on the computer

Verifying your Installation

- ◆ Access the *Device Manager* through the *Control Panel/System/Device Manager*. On the *Device Manager* tab of the *System Property* sheet, you can see the *Device Name* of the PCI-1712/1712L listed on it.

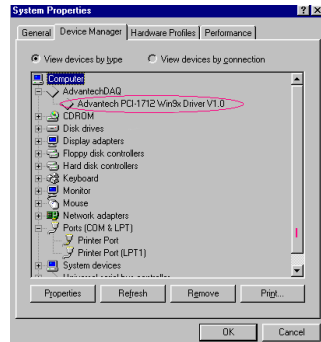

Device Installation

Step 1: Run the *Device Installation* program (by accessing *Start/Programs/ Advantech Driver for 95 and 98 (or for NT)/Device Installation*).

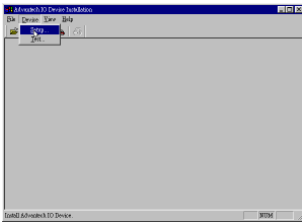

Step 2: On the *Device Installation* program window, select the **Device** menu item on the menu bar, and click the **Setup** command to bring up the *I/O Device Installation* dialog box as below:

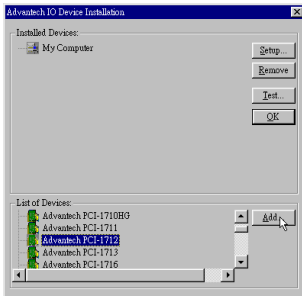

Step 3: Scroll down the *List of Devices* box to find the device that you wish to configure, then click the **Add** button to bring up the *Device Found(s)* dialog box as shown below:

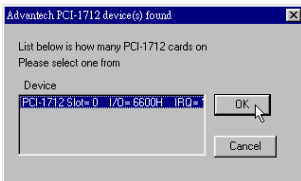

Step 4: After selecting a device and click **OK**, the *Device Setting* dialog box will pop up. You can configure various settings for the selected device.

Step 5: After you have finished configuring of the device, click **OK** and the device will appear in the *Installed Devices* box as seen below:

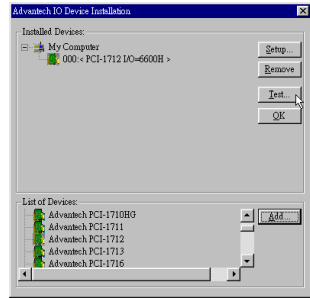

Step 6: After your card is properly installed and configured, you can click the **Test** button to test your hardware.

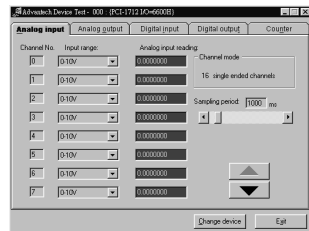

Step 7: You can test your hardware by using the testing utility we supplied. For more detailed information, please refer to Chapter 2 of the User's Manual .

Copyright®

This documentation and the software included with this product are copyrighted 2001 by Advantech Co., Ltd. All rights are reserved. Advantech Co., Ltd. reserves the right to make improvements in the products described in this manual at any time without notice.

No part of this manual may be reproduced, copied, translated or transmitted in any form or by any means without the prior written permission of Advantech Co., Ltd. Information provided in this manual is intended to be accurate and reliable. However, Advantech Co., Ltd. assumes no responsibility for its use, nor for any infringements of the rights of third parties which may result from its use.

Acknowledgments

PC-LabCard is a trademark of Advantech Co., Ltd. IBM and PC are trademarks of International Business Machines Corporation. MS-DOS, Windows®, Microsoft® Visual C++ and Visual BASIC are trademarks of Microsoft® Corporation. Intel® and Pentium® are trademarks of Intel Corporation. Delphi and C++Builder are trademarks of Inprise Corporation.

CE notification

The PCI-1712/1712L, developed by ADVANTECH CO., LTD., has passed the CE test for environmental specifications when shielded cables are used for external wiring. We recommend the use of shielded cables. This kind of cable is available from Advantech. Please contact your local supplier for ordering information.

On-line Technical Support

For technical support and service, please visit our support website at:

<http://www.advantech.com/support>

Part No. 2003171201 2nd Edition
Printed in Taiwan March 2001

Contents

1. Introduction	1
1.1 Features	1
1.2 Installation Guide	3
1.3 Accessories	5
2. Installation	7
2.1 Unpacking	7
2.2 Driver Installation	8
2.3 Hardware Installation	9
2.4 Device Setup & Configuration	12
2.5 Device Testing	15
3. Signal Connections	19
3.1 Overview	19
3.2 I/O Connector	19
3.3 Analog Input Connections	24
3.4 Analog Output Connections	27
3.5 Field Wiring Considerations	28
4. Software Overview	29
4.1 Programming Choices	29
4.2 DLL Driver Programming Roadmap	30
5. Principles of Operation	33
5.1 Analog Input Features	33
5.2 Analog Output Features	40
5.3 Digital I/O Features	43
5.4 Counter/Timer Features	44

6. Calibration	55
6.1 VR Assignment	55
6.2 A/D Calibration	56
6.3 D/A Calibration	57
6.4 Calibration Utility	58
Appendix A. Specification	69
Appendix B. Block Diagram	73
Appendix C. Screw-terminal Board	75
C.1 Introduction	75
C.2 Features	75
C.3 Board Layout	75
C.4 Pin Assignment	76
C.5 Single-ended Connections	77
C.6 Differential Connections	78
Appendix D. Register Structure and Format	79
D.1 Overview	79
D.2 I/O Port Address Map	79
D.3 A/D Single Value Acquisition — Write BASE+0	83
D.4 Channel and A/D data — Read BASE + 0	83
D.5 A/D Channel Range Setting — Write BASE+2	84
D.6 MUX Control — Write BASE+4	85
D.7 A/D Control/Status Register — Write/Read BASE+6	87
D.8 Clear interrupt and FIFO — Write BASE+8	89
D.9 Interrupt and FIFO status — Read BASE+8	90
D.10 D/A control/status register — Write/Read BASE+A	91
D.11 D/A Channel 0/1 Data — Write BASE+C/E	93
D.12 82C54 Counter Chip 0 — Write/Read BASE+10 to 16	94
D.13 82C54 counter chip 1 — Write/Read BASE+18 to 1E	95

D.14 Counter gate and clock control/status — Write/ Read BASE+20 to 26	96
D.15 Digital I/O registers — Write/Read BASE+28	99
D.16 Digital I/O configuration registers — Write/Read BASE+2A	100
D.17 Calibration command registers — Write BASE+2C	100
D.18 D/A Channel Data for Continuous Output Operation Mode — Write BASE+30	102

Figures

Figure 2-1: The Setup Screen of Advantech Automation Software	8
Figure 2-2: Different options for Driver Setup	9
Figure 2-3: The device name listed on the Device Manager	11
Figure 2-4: The Advantech Device Installation utility program	12
Figure 2-5: The I/O Device Installation dialog box	12
Figure 2-6: The “Device(s) Found” dialog box	13
Figure 2-7: The Device Setting dialog box	13
Figure 2-8: The Device Name appearing on the list of devices box	14
Figure 2-9: Analog Input tab on the Device Test dialog box	15
Figure 2-10: Analog Input tab on the Device Test dialog box	16
Figure 2-11: Analog Output tab on the Device Test dialog box	16
Figure 2-12: Digital Input tab on the Device Test dialog box	17
Figure 2-13: Digital Output tab on the Device Test dialog box	17
Figure 2-14: Digital output tab on the Device Test dialog box	18
Figure 3-1: I/O connector pin assignments for the PCI-1712/1712L ...	20
Figure 3-2: Single-ended input channel connection	24
Figure 3-3: Differential input channel connection - ground reference signal source	25
Figure 3-4: Differential input channel connection - floating signal source	26
Figure 3-5: Analog output connections	27
Figure 5-1: Post-Trigger Acquisition Mode	35
Figure 5-2: Delay-Trigger Acquisition Mode	35
Figure 5-3: About-Trigger Acquisition Mode	36
Figure 5-4: Pre-Trigger Acquisition Mode	37
Figure 5-5: PCI-1712/1712L Sample Clock Source	38
Figure 5-6: Frequency measurement	49
Figure 6-1: PCI-1712/1712L VR1 & TP5	55
Figure 6-2: Selecting the device you want to calibrate	58
Figure 6-3: Warning message before start calibration	59

Figure 6-4: Auto A/D Calibration Dialog Box	59
Figure 6-5: A/D Calibration Procedure 1	60
Figure 6-6: A/D Calibration Procedure 2	60
Figure 6-7: A/D Calibration Procedure 3	61
Figure 6-8: A/D Calibration is finished	61
Figure 6-9: Range Selection in D/A Calibration	62
Figure 6-10: Calibrating D/A Channel 0	62
Figure 6-11: Calibrating D/A Channel 1	63
Figure 6-12: D/A Calibration is finished	63
Figure 6-13: Selecting Input Range in Manual A/D Calibration panel	64
Figure 6-14: Adjusting registers	65
Figure 6-15: Selecting D/A Range and	66
Figure 6-16: Selecting D/A Range and	66
Figure 6-17: Adjusting registers	67
Figure C-1: PCLD-8712 board layout	75
Figure C-2: CN2 pin assignments for the PCLD-8712	76

Tables

Table 3-1:	I/O Connector Signal Description (Part 1)	21
Table 3-1:	I/O Connector Signal Description (Part 2)	22
Table 3-1:	I/O Connector Signal Description (Part 3)	23
Table 5-1:	Gains and Analog Input Range	33
Table 5-2:	Analog Input Data Format	39
Table 5-3:	The corresponding Full Scale values for various Input Voltage Ranges	39
Table 5-4:	Analog Output Data Format	43
Table 5-5:	The corresponding Full Scale values for various Output Voltage Ranges	43
Table D-1:	PCI-1712/1712L register format (Part 1)	80
Table D-1:	PCI-1712/1712L register format (Part 2)	81
Table D-1:	PCI-1712/1712L register format (Part 3)	82
Table D-2:	Register for channel number and A/D data	83
Table D-3:	Register for A/D channel range setting	84
Table D-4:	Gain Codes for the PCI-1712/1712L	85
Table D-5:	Register for multiplexer control	85
Table D-6:	Register for A/D control/status	87
Table D-7:	Analog Input Acquisition Mode	88
Table D-8:	Register for clear interrupt and FIFO	89
Table D-9:	Register for interrupt and FIFO status	90
Table D-10:	Register for D/A control	91
Table D-11:	Analog output operation mode	92
Table D-12:	Register for D/A channel 0/1 data	93
Table D-13:	Register for 82C54 counter chip 0	94
Table D-14:	Register for 82C54 counter chip 1	95
Table D-15:	Register for counter gate and clock control/status	96
Table D-16 :	Table of Cn1 to Cn0 register	96
Table D-17:	Table of Gn1 to Gn0 register	97
Table D-18:	Table for CLK_SEL1 to CLK_SEL0 register	99

Table D-19: Register for Digital I/O	99
Table D-20: Register for digital I/O configuration	100
Table D-21: Register for digital I/O configuration	100
Table D-22: Register for calibration command	100
Table D-23: Calibration command	101
Table D-24: Register for D/A channel data	102

1. Introduction

Thank you for buying the Advantech PCI-1712/1712L PCI card. The PCI-1712/1712L is a powerful high-speed multifunction DAS card for PCI bus. It features a 1MHz 12-bit A/D converter, an on-board FIFO buffer (storing up to 1K samples for A/D, and up to 32K samples for D/A conversion). The PCI-1712/1712L provides a total of up to 16 *single-ended* or 8 *differential A/D input channels* or a mixed combination, 2 *12-bit D/A output channels*, 16 *digital input/output channels*, and 3 *10MHz 16-bit multifunction counter channels*. PCI-1712/1712L provides specific functions for different user requirements:

PCI-1712 1 MS/s High-Speed Multifunction Card

PCI-1712L 1 MS/s High-Speed Multifunction Card w/o analog output

The following sections of this chapter will provide further information about features of the DAS card, a Quick Start for installation, together with some brief information on software and accessories for the PCI-1712/1712L card.

1.1 Features

The Advantech PCI-1712/1712L provides users with the most requested measurement and control functions as seen below:

- PCI-bus mastering for data transfer
- 16 single-ended or 8 differential or combination analog inputs
- 12-bit A/D converter, with up to 1 MHz sampling rate
- Pre-, post-, about- and delay-trigger data acquisition modes for analog input channels
- Programmable gain for each analog input channel
- Automatic channel/gain/SD/BU scanning
- On-board FIFO buffer storing up to 1K samples for A/D and 32K samples for D/A
- Two 12-bit analog output channels with continuous waveform output function
- Auto calibration for analog input and output channels
- 16 digital Input and output channels
- Three 16-bit programmable multifunction counters/timers on 10MHz clock.

The Advantech PCI-1712 offers the following main features:

PCI-Bus Mastering Data Transfer

The PCI-1712/1712L supports *PCI-Bus mastering DMA* for high-speed data transfer and gap-free analog input and analog output. By setting aside a block of memory in the PC, the PCI-1712/1712L performs bus-mastering data transfers without CPU intervention, setting the CPU free to perform other more urgent tasks such as data analysis and graphic manipulation. The function allows users to run all I/O functions simultaneously at full speed without losing data.

Plug-and-Play Function

The PCI-1712/1712L is a Plug-and-Play device, which fully complies with the PCI Specification Rev 2.2. During card installation, you have no need to set any jumpers or DIP switches. Instead, all bus-related configurations such as base I/O address and interrupt are automatically done by the Plug-and-Play function.

On-board FIFO Memory

The PCI-1712/1712L provides an *on-board FIFO* (First In First Out) memory buffer, storing up to 1K samples for A/D and 32K for D/A conversion (PCI-1712 only).

Automatic Channel/Gain/SD*/BU* Scanning

PCI-1712/1712L features an *automatic channel/Gain/SD/BU scanning circuit*. This circuit controls multiplexer switching during sampling in a way that is much more efficient than software implementation. *On-board SRAM* stores different gain, SD and BU values for each channel. This combination lets user perform multi-channel high-speed sampling with different gain, SD and BU values for each channel.

SD: Single-Ended/Differential Analog Input

BU: Bipolar/Unipolar

Flexible Triggering and Clocking Capabilities

The PCI-1712/1712L provides flexibility in triggering action, both in the available trigger modes and trigger events for analog input. You can acquire data using *post-trigger*, *pre-trigger*, *delay-trigger* and *about-trigger* modes. The trigger source could be either analog or digital signal. The analog trigger could originate from a dedicated input pin. In fact, you can designate any of the analog input channels as the analog trigger input. You can also set the analog trigger level within a voltage range from zero to A/D FSR. When trigger signal being digital, you can pace A/D and D/A conversion using software interrupt, internal or external clock.

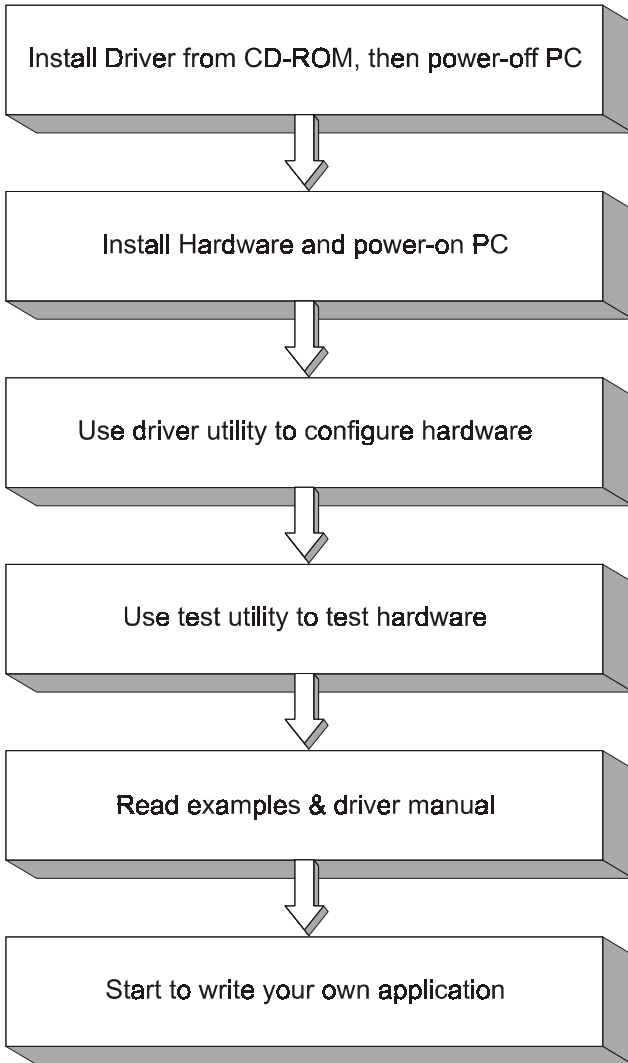

Figure 1-1: Installation Flow Chart

- ❑ **Application software** ActiveDAQ, GeniDAQ or other third-party software packages

After you have got the necessary components and maybe some accessories for enhanced operation of your DAS card, you can then begin the Installation procedures. Figure 1-1 on the next page provides a concise flow chart to give users a broad picture of the software and hardware installation procedures:

1.3 Accessories

Advantech offers a complete set of accessory products to support the PCI-1712/1712L cards. These accessories include:

Wiring Cable

- ❑ **PCL-10168** The PCL-10168 shielded cable is specially designed for PCI-1712/1712L card to provide higher resistance to noise. To achieve a better signal quality, the signal wires are twisted in such a way as to form a twisted-pair cable, reducing crosstalk and noise from other signal sources. Furthermore, its analog and digital lines are separately sheathed and shielded to neutralize EMI/EMC problems.

Wiring Boards

- ❑ **ADAM-3968** The ADAM-3968 is a 68-pin SCSI wiring terminal module for DIN-rail mounting. This terminal module can be readily connected to the Advantech PC-Lab cards and allow easy yet reliable access to individual pin connections for the PCI-1712/1712L card.
- ❑ **PCLD-8712** The PCLD-8712 is a DIN-rail mounting screw-terminal board to be used with any of the PC-LabCards which have 68-pin SCSI connectors. The PCLD-8712 features the following functions:
 - One additional 20-pin flat-cable connectors for digital input and output
 - Reserved space on the board to meet future needs for signal-conditioning circuits (low-pass filter, voltage attenuator and current shunt)

Chapter 1

- Industrial-grade screw-clamp terminal blocks for heavy-duty and reliable connections.

2. Installation

This chapter gives users a package item checklist, proper instructions about unpacking and step-by-step procedures for both driver and card installation.

2.1 Unpacking

After receiving your PCI-1712/1712L package, please inspect its contents first. The package should contain the following items:

- PCI-1712/1712L card
- Companion CD-ROM (DLL driver included)
- User's Manual
- Quick Start

The PCI-1712/1712L card harbors certain electronic components vulnerable to *electrostatic discharge* (ESD). ESD could easily damage the integrated circuits and certain components if preventive measures are not carefully paid attention to. ***Before removing the card from the antistatic plastic bag, you should take following precautions to ward off possible ESD damage:***

- Touch the metal part of your computer chassis with your hand to discharge static electricity accumulated on your body. Or one can also use a grounding strap.
- Touch the antistatic bag to a metal part of your computer chassis before opening the bag.
- Take hold of the card only by the metal bracket when removing it out of the bag.

After taking out the card, first you should:

- Inspect the card for any possible signs of external damage (loose or damaged components, etc.). If the card is visibly damaged, please notify our service department or our local sales representative immediately. Avoid installing a damaged card into your system.

Also pay extra caution to the following aspects to ensure proper installation:



Avoid physical contact with materials that could hold static electricity such as plastic, vinyl and Styrofoam.

 Whenever you handle the card, grasp it only by its edges. **DO NOT TOUCH** the exposed metal pins of the connector or the electronic components.

Note:

- ⚡ Keep the antistatic bag for future use. You might need the original bag to store the card if you have to remove the card from PC or transport it elsewhere.
-

2.2 Driver Installation

We recommend you to install the driver before you install the PCI-1712/1712L card into your system, since this will guarantee a smooth installation process.

The 32-bit DLL driver Setup program for the card is included on the companion CD-ROM that is shipped with your DAS card package. Please follow the steps below to install the driver software:

Step 1: Insert the companion CD-ROM into your CD-ROM drive.

Step 2: The Setup program will be launched automatically if you have the autoplay function enabled on your system. When the Setup Program is launched, you'll see the following Setup Screen.

Note:

- ⚡ If the autoplay function is not enabled on your computer, use Windows Explorer or Windows *Run* command to execute SETUP.EXE on the companion CD-ROM.
-

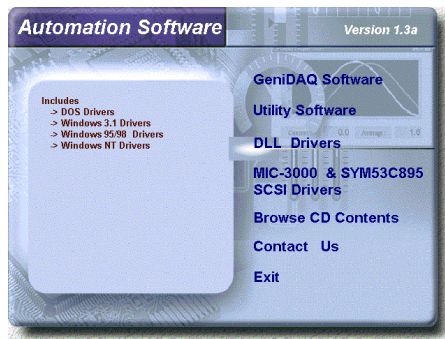

Figure 2-1: The Setup Screen of Advantech Automation Software

Step 3: Select the *DLL Drivers* option.

Step 4: Select the *Windows 95/98* or *Windows NT* option according to your operating system. Just follow the installation instructions step by step to complete your DLL driver setup.

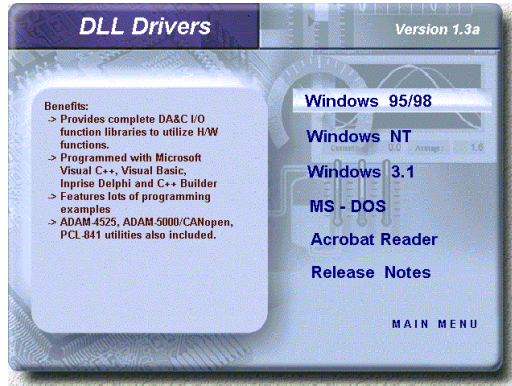

Figure 2-2: Different options for Driver Setup

For further information on driver-related issues, an online version of *DLL Drivers Manual* is available by accessing the following path:
Start/Programs/Advantech Driver for 95 and 98 (or for NT)/Driver Manual

2.3 Hardware Installation

Note:

- ✎ Make sure you have installed the driver first before you install the card (please refer to 2.2 *Driver Installation*)
-

After the DLL driver installation is completed, you can now go on to install the PCI-1712/1712L card in any PCI slot on your computer. But it is suggested that you should refer to the computer user manual or related documentations if you have any doubt. Please follow the steps below to install the card on your system.

Step 1: Turn off your computer and unplug the power cord and cables.

- ⚡ **TURN OFF** your computer before installing or removing any components on the computer.

- Step 2:** Remove the cover of your computer.
- Step 3:** Remove the slot cover on the back panel of your computer.
- Step 4:** Touch the metal part on the surface of your computer to neutralize the static electricity that might be on your body.
- Step 5:** Insert the PCI-1712/1712L card into a PCI slot. Hold the card only by its edges and carefully align it with the slot. Insert the card firmly into place. Use of excessive force must be avoided, otherwise the card might be damaged.
- Step 6:** Fasten the bracket of the PCI card on the back panel rail of the computer with screws.
- Step 7:** Connect appropriate accessories (68-pin cable, wiring terminals, etc. if necessary) to the PCI card.
- Step 8:** Replace the cover of your computer chassis. Re-connect the cables you removed in step 2.
- Step 9:** Plug in the power cord and turn on the computer .

Note:

- ⚠ In case you installed the card without installing the DLL driver first, Windows 95/98 will recognize your card as an “unknown device” after reboot, and will prompt you to provide necessary driver. You should ignore the prompting messages (just click the **Cancel** button) and set up the driver according to the steps described in 2.2 *Driver Installation*.
-

After the PCI-1712/1712L card is installed, you can verify whether it is properly installed on your system in the *Device Manager*:

1. Access the *Device Manager* through *Control Panel/System/Device Manager*.
2. The *device name* of the PCI-1712/1712L should be listed on the *Device Manager* tab on the *System Property* Page.

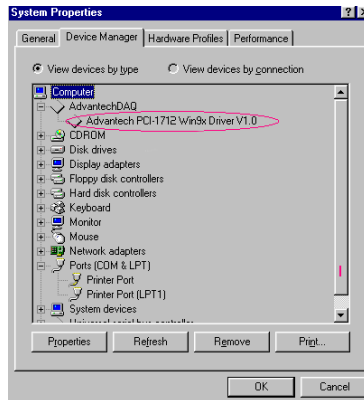

Figure 2-3: The device name listed on the Device Manager

Note:

- ✎ If your card is properly installed, you should see the *device name* of your card listed on the *Device Manager* tab. **If you do see your device name listed on it but marked with an exclamation sign “!”, it means your card has not been correctly installed.** In this case, remove the card device from the *Device Manager* by selecting its device name and press the **Remove** button. Then go through the driver installation process again.
-

After your card is properly installed on your system, you can now configure your device using the *Device Installation Program* that has itself already been installed on your system during driver setup. A complete device installation procedure should include *device setup*, *configuration* and *testing*. The following sections will guide you through the Setup, Configuration and Testing of your device.

2.4 Device Setup & Configuration

The *Device Installation* program is a utility that allows you to set up, configure and test your device, and later stores your settings on the system registry. These settings will be used when you call the APIs of Advantech 32-bit DLL drivers.

Setting Up the Device

Step 1: To install the I/O device for your card, you must first run the *Device Installation* program (by accessing *Start/Programs/Advantech Driver for 95 and 98 (or for NT)/Device Installation*).

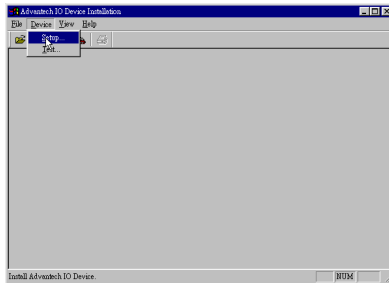

Figure 2-4: The Advantech Device Installation utility program

Step 2: On the *Device Installation* program window, select the *Device* menu item on the menu bar, and click the *Setup* command (Fig. 2-4) to bring up the *I/O Device Installation* dialog box (Fig. 2-5). You can then view the device(s) already installed on your system (if any) on the *Installed Devices* list box.

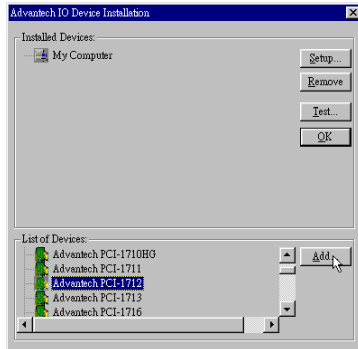

Figure 2-5: The I/O Device Installation dialog box

Step 3: Scroll down the *List of Devices* box to find the device that you wish to install, then click the **Add** button to evoke the *Device(s) Found* dialog box such as one shown in Fig. 2-6. The *Device(s) Found* dialog box lists all the installed devices on your system. Select the device you want to configure from the list box and press the **OK** button. After you have clicked **OK**, you will see a *Device Setting* dialog box such as the one in Fig. 2-7.

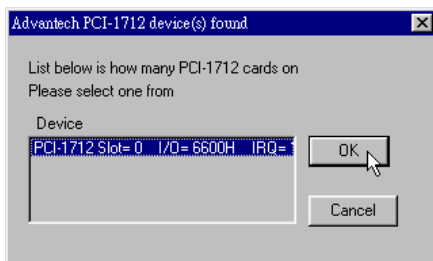

Figure 2-6: The “Device(s) Found” dialog box

Configuring the Device

Step 4: On the *Device Setting* dialog box (Fig. 2-7), you can configure the parameters of A/D, D/A, DIO and Counter functions.



Figure 2-7: The Device Setting dialog box

Note:

Users can configure the source of D/A reference voltage either as *Internal* or *External*, and then select for the *unipolar* or the *bipolar*

2.5 Device Testing

Following through the *Setup* and *Configuration* procedures to the last step described in the previous section, you can now proceed to test the device by clicking the **Test** Button on the *I/O Device Installation* dialog box (Fig. 2-8). A *Device Test* dialog box will appear accordingly:

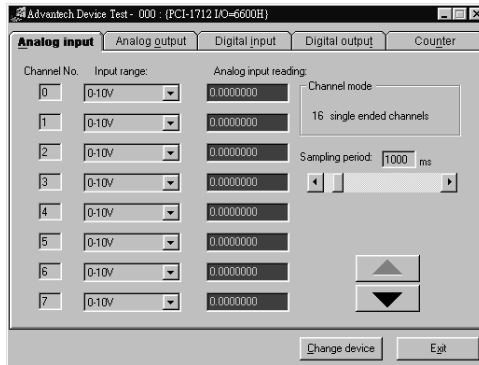

Figure 2-9: Analog Input tab on the Device Test dialog box

On the *Device Test* dialog box, users are free to test various functions of PCI-1712/1712L on the *Analog input*, *Analog output*, *Digital input*, *Digital output* or *Counter* tabs.

Note:

- You can access the *Device Test* dialog box either by the previous procedure for the Device Installation Program or simply by accessing *Start/Programs/Advantech Driver for 95 and 98 (or for NT) /Test Utility*.
-

Testing Analog Input Function

Click the *Analog Input* tab to bring it up to front of the screen. Select the input range for each channel in the *Input range* drop-down boxes. Configure the sampling rate on the scroll bar. Switch the channels by using the up/down arrow.

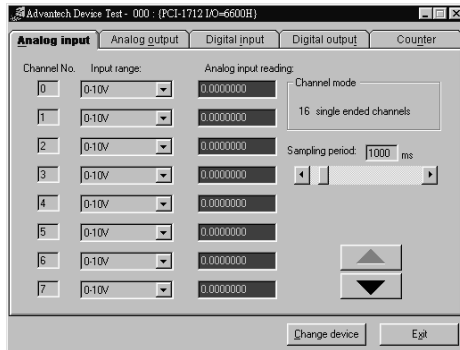

Figure 2-10: Analog Input tab on the Device Test dialog box

Testing Analog Output Function (PCI-1712 only)

Click the *Analog Output* tab to bring it up to the foreground. The *Analog Output* tab allows you to output quasi-sine, triangle, or square waveforms generated by the software automatically, or output single values manually. You can also configure the waveform frequency and output voltage range.

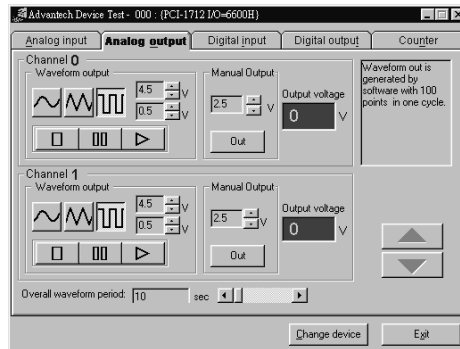

Figure 2-11: Analog Output tab on the Device Test dialog box

Testing Digital Input Function

Click the *Digital Input* tab to show forth the *Digital Input* test panel as seen below. Through the color of the lamps, users can easily discern whether the status of each digital input channel is either high or low.

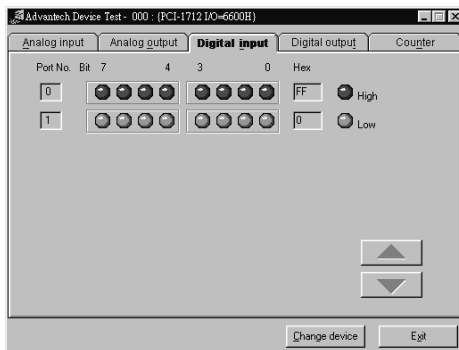

Figure 2-12: Digital Input tab on the Device Test dialog box

Testing Digital Output Function

Click the *Digital Output* tab to bring up the *Digital Output* test panel such as seen on the next page. By pressing the buttons on each tab, users can easily set each digital output channel as *high* or *low* for the corresponding port.

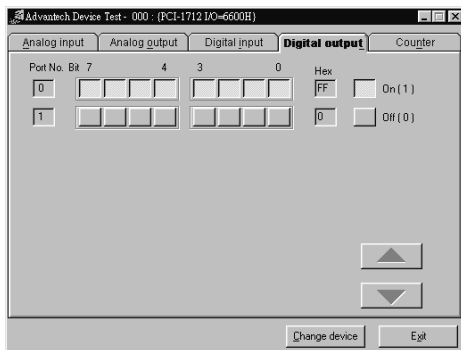

Figure 2-13: Digital Output tab on the Device Test dialog box

Testing Counter Function

Click the *Counter* Tab to bring its test panel forth. In the test utility, the counter channel (*Channel 0*) offers the users two options: *Event counting* and *Pulse out*. If you select *Event counting*, you need first to connect your clock source to pin CNT0_CLK, and the counter will start counting after the pin CNT0_GATE is triggered. If you select *Pulse Out*, the clock source will be output to pin CNT0_OUT. You can

configure the *Pulse Frequency* by the scroll bar right below it.

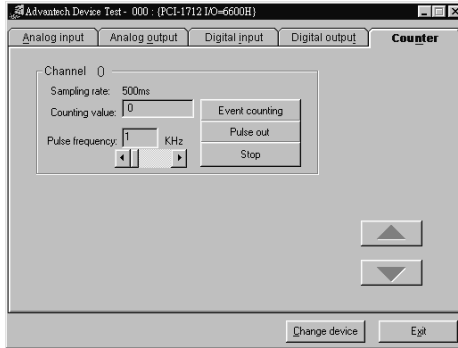

Figure 2-14: Digital output tab on the Device Test dialog box

Only after your card device is properly set up, configured and tested, can the device installation procedure be counted as complete. After the device installation procedure is completed, you can now safely proceed to the next chapter, *Signal Connections*.

3. Signal Connections

3.1 Overview

Maintaining proper signal connections is one of the most important factors to ensure that your application system is sending and receiving data correctly. A good signal connection can avoid unnecessary and costly damage to your PC and other hardware devices. This chapter provides useful information about how to connect input and output signals to the PCI-1712/1712L via the I/O connector.

3.2 I/O Connector

The I/O connector on the PCI-1712/1712L is a 68-pin connector that enables you to connect to accessories with the PCL-10168 shielded cable.

Note:

- ⚡ The PCL-10168 shielded cable is especially designed for the PCI-1712/1712L to reduce noise in the analog signal lines. Please refer to *Section 1.3 Accessories*.
-

Pin Assignment

Figure 3-1 shows the pin assignments for the 68-pin I/O connector on the PCI-1712/1712L, and table 3-1 lists the detailed illustration of the pins.

Note:

- ⚡ The three ground references AIGND, AOGND, and DGND should be used discreetly each according to its designated purpose.
-

AI0	68	34	AI1
AI2	67	33	AI3
AI4	66	32	AI5
AI6	65	31	AI7
AI8	64	30	AI8
AI10	63	29	AI11
AI12	62	28	AI13
AI14	61	27	AI15
AI_GND	60	26	ANA_TRG
AO0_REF	59	25	AO1_REF
AO0_OUT	58	24	AO1_OUT
AO_GND	57	23	AO_GND
AI_CLK	56	22	AI_TRG
DGND	55	21	DGND
AO_CLK	54	20	AO_TRG
CNT0_CLK	53	19	CNT0_GATE
CNT0_OUT	52	18	DGND
CNT1_CLK	51	17	CNT1_GATE
CNT1_OUT	50	16	DGND
CNT2_CLK	49	15	CNT2_GATE
CNT2_OUT	48	14	DGND
DIO0	47	13	DIO1
DIO2	46	12	DIO3
DIO4	45	11	DIO5
DIO6	44	10	DIO7
DGND	43	9	DGND
DIO8	42	8	DIO9
DIO10	41	7	DIO11
DIO12	40	6	DIO13
DIO14	39	5	DIO15
DGND	38	4	DGND
AI_TRG_OUT	37	3	AI_CLK_OUT
NC	36	2	NC
+12V	35	1	+5V

Figure 3-1: I/O connector pin assignments for the PCI-1712/1712L

*: Pins 20, 22~25, 54, 56~59 are not defined on PCI-1712L

I/O Connector Signal Description

Signal Name	Reference	Direction	Description
AI<0...15>	AIGND	Input	Analog Input Channels 0 through 15. Each channel pair, AI<i, i+8> (i = 0...7), can be configured as either one differential input or two single-ended inputs.
AIGND	-	-	Analog Input Ground. These pins are the reference points for single-ended measurements and the bias current return point for differential measurement. All three ground references- AIGND, AOGND and DGND- are connected together on the PCI-1712 card.
AO0_REF	AOGND	Input	Analog Channel 0 Output External Reference. This is the external reference input for the analog output channel 0 circuitry.
AO1_REF	AOGND	Input	Analog Channel 1 Output External Reference. This is the external reference input for the analog output channel 1 circuitry.
ANA_TRG	AIGND	Input	Analog threshold Trigger. This pin is the analog input threshold trigger input.
AO0_OUT	AOGND	Output	Analog Channel 0 Output. This pin supplies the voltage output of analog output channel 0.
AO1_OUT	AOGND	Output	Analog Channel 1 Output. This pin supplies the voltage output of analog output channel 1.
AI_CLK	DGND	Input	Analog Input external clock input. This is the external clock input for the analog input.
AI_TRG	DGND	Input	Analog Input TTL Trigger- This is the TTL trigger for analog trigger.
AOGND	-	-	Analog Output Ground. The analog output voltages are referenced to these nodes. All three ground references- AIGND, AOGND, and DGND- are connected together on your PCI-1712 card.

Table 3-1: I/O Connector Signal Description (Part 1)

Signal Name	Reference	Direction	Description
DIO<0..15>	DGND	Input	Digital Input / Output signals. These pins are digital input / output channel 0 to 15
AI_CLK	DGND	Input	Analog Input external clock input. This is the external clock input for the analog input.
AI_TRG	DGND	Input	Analog Input TTL Trigger- This is the TTL trigger for analog trigger.
AI_CLK_OUT	DGND	Output	Analog Input Clock Output. This pin pulses once for each pacer clock. This signal serves as a synchronous signal for application. The low-to-high edge start A/D conversion.
AI_TRG_OUT	DGND	Output	Analog Input Trigger Output. This pin outputs the analog input trigger signal. The low-to-high edge indicates the trigger event.
DGND	-	-	Digital Ground. This pin supplies the reference for the digital signals at the I/O connector as well as the +5VDC supply. All three ground references- AIGND, AOGND, and DGND- are connected together on your PCI-1712 card.

Table 3-1: I/O Connector Signal Description (Part 2)

Signal Name	Reference	Direction	Description
CNT0_CLK	DGND	Input	Counter 0 Clock Input. This pin is the counter 0 external clock input (up to 10MHz), counter 0 clock can be either internal set by software.
CNT0_GATE	DGND	Input	Counter 0 Gate Input. This pin is for counter 0 gate control, see 82C54 data sheet for detailed information.
CNT0_OUT	DGND	Output	Counter 0 Output. This pin is counter 0 output, see 82C54 data sheet for detailed information.
CNT1_CLK	DGND	Input	Counter 1 Clock Input. This pin is the counter 1 external clock input (up to 10MHz), counter 1 clock can be either internal set by software.
CNT1_GATE	DGND	Input	Counter 1 Gate Input. This pin is for counter 1 gate control, see 82C54 data sheet for detailed information.
CNT1_OUT	DGND	Output	Counter 1 Output. This pin is counter 1 output, see 82C54 data sheet for detailed information.
CNT2_CLK	DGND	Input	Counter 2 Clock Input. This pin is the counter 2 external clock input (up to 10MHz), counter 2 clock can be either internal set by software.
CNT2_GATE	DGND	Input	Counter 2 Gate Input. This pin is for counter 2 gate control, see 82C54 data sheet for detailed information.
CNT2_OUT	DGND	Output	Counter 2 Output. This pin is counter 2 output, see 82C54 data sheet for detailed information.
+12V	DGND	Output	+12 VDC Source. This pin is +12V power supply.
+5V	DGND	Output	+5 VDC Source. This pin is +5 V power supply.
NC	-	-	No Connection. These pins serve no connection.

Table 3-1: I/O Connector Signal Description (Part 3)

3.3 Analog Input Connections

The PCI-1712/1712L supports either 16 single-ended or 8 differential analog inputs. Each individual input channel is software-selected.

Single-ended Channel Connections

The single-ended input configuration has only one signal wire for each channel, and the *measured voltage* (V_m) is the voltage of the wire as referenced against the common ground.

A signal source without a local ground is also called a “floating source”. It is fairly simple to connect a single-ended channel to a floating signal source. In this mode, the PCI-1712/1712L provides a reference ground for external floating signal sources.

Figure 3-2 shows a single-ended channel connection between a floating signal source and an input channel on the PCI-1712/1712L.

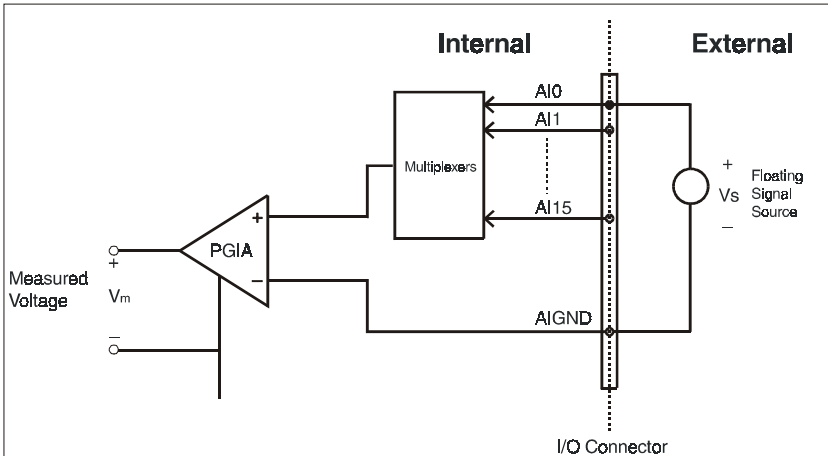

Figure 3-2: Single-ended input channel connection

Differential Channel Connections

The differential input channels operate with two signal wires for each channel, and the voltage difference between both signal wires is measured. On the PCI-1712/1712L, when all channels are configured to differential input, up to 8 analog channels are available.

If one side of the signal source is connected to a local ground, the signal source is ground-referenced. Therefore, the ground of the signal source and the ground of the card will not be exactly of the

same voltage. The difference between the ground voltages forms a common-mode voltage (V_{cm}).

To avoid the ground loop noise effect caused by common-mode voltages, you can connect the signal ground to the Low input. Figure 3-3 shows a differential channel connection between a ground-reference signal source and an input channel on the PCI-1712/1712L. With this connection, the PGIA rejects a common-mode voltage V_{cm} between the signal source and the PCI-1712/1712L ground, shown as V_{cm} in Figure 3-3.

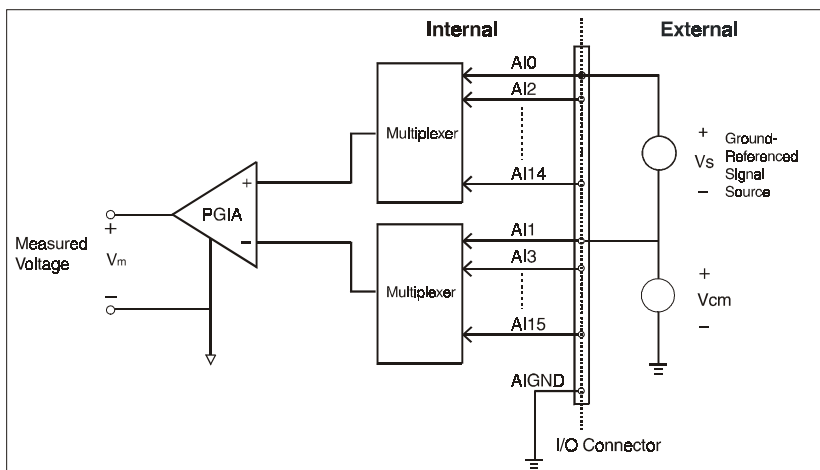

Figure 3-3: Differential input channel connection - ground reference signal source

If a floating signal source is connected to the differential input channel, the signal source might exceed the common-mode signal range of the PGIA, and the PGIA will be saturated with erroneous voltage-readings. You must therefore reference the signal source against the AIGND.

Figure 3-4 shows a differential channel connection between a floating signal source and an input channel on the PCI-1712/1712L. In this figure, each side of the floating signal source is connected through a resistor to the AIGND. This connection can reject the common-mode voltage between the signal source and the PCI-1712/1712L ground.

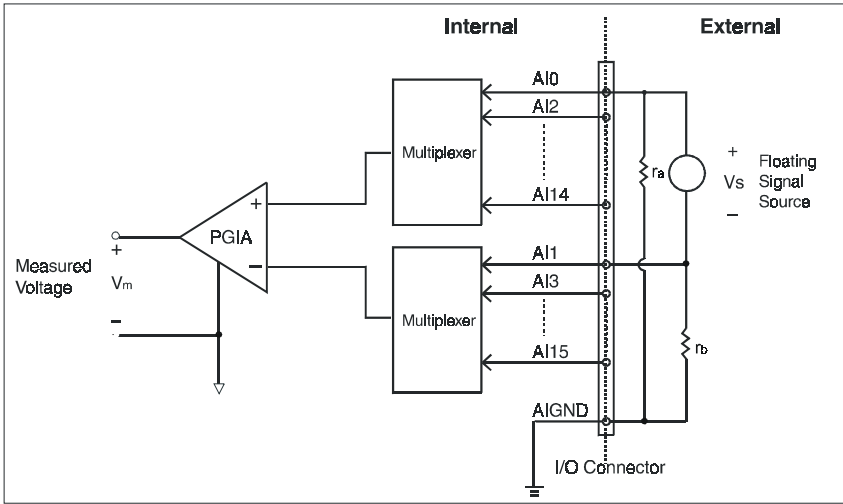
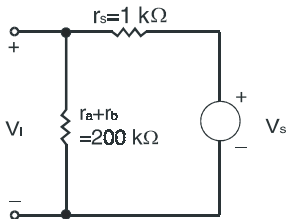

Figure 3-4: Differential channel connection - floating signal source

However, this connection has the disadvantage of loading the source down with the series combination (sum) of the two resistors. For r_a and r_b , for example, if the input impedance r_s is 1 k Ω , and each of the two resistors is 100 k Ω , then the resistors load down the signal source with 200 k Ω (100 k Ω + 100 k Ω), resulting in a -0.5% gain error. The following gives a simplified representation of the circuit and calculating process.



- V_s : ideal signal source
- V_i : measured signal source
- r_s : output impedance of signal source
- r_a, r_b : series-wound resistors

$$V_i = \frac{r_a + r_b}{r_s + r_a + r_b} V_s = \frac{200}{1 + 200} V_s = \frac{200}{201} V_s$$

$$\text{Gain error} = \frac{V_i - V_s}{V_s} = - \frac{1}{201} = -0.5\%$$

3.4 Analog Output Connections

The PCI-1712 provides two D/A output channels, **AO0_OUT** and **AO1_OUT**. Users may use the PCI-1712 internally-provided precision +5V (+10V) reference to generate 0 ~ +5 V and 0 ~ +10 V unipolar D/A output range; or to generate -5 ~ +5 V and -10 ~ +10 V for bipolar output range.

Users may also set D/A output range through external references, **AO0_REF** and **AO1_REF**. The external reference input range is 0~10 V. For example, connecting with an external reference of +7 V will generate 0 ~ +7 V D/A output for *unipolar*; and -7 ~ +7 V for *bipolar*.

Figure 3-5 shows how to make analog output and external reference input connections on the PCI-1712.

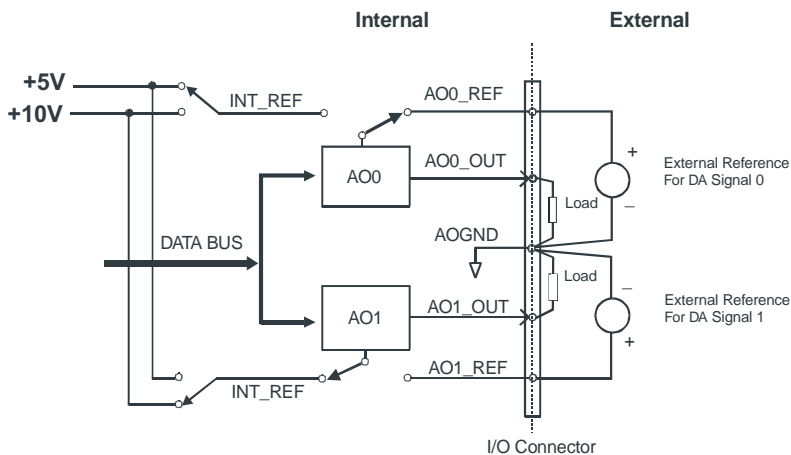

Figure 3-5: Analog output connections

3.5 Field Wiring Considerations

When you use the PCI-1712/1712L to acquire data from outside, noises in the environment might significantly affect the accuracy of your measurements if due cautions are not taken. The following measures will be helpful to reduce possible interference running signal wires between signal sources and the PCI-1712/1712L.

- The signal cables must be kept away from strong electromagnetic sources such as power lines, large electric motors, circuit breakers or welding machines, since they may cause strong electromagnetic interference. Keep the analog signal cables away from any video monitor, since it can significantly affect data acquisition system.
- If the cable travels through area with significant electromagnetic interference, you should adopt individually shielded, twisted-pair wires as the analog input cable. This type of cable have its signal wires twisted together and shielded with a metal mesh. The metal mesh should only be connected to one point at the signal source ground.
- Avoid running the signal cables through any conduit that might have power lines in it.
- If you have to place your signal cable parallel to a power line that has a high voltage or high current running through it, try to keep a safe distance between them. Or you should place the signal cable at right angle to the power line to minimize the undesirable effect.
- The signals transmitted on the cable will be directly affected by the quality of the cable. In order to ensure best signal quality, we recommend that you use the PCL-10168 shielded cable.

4. Software Overview

This chapter gives you an overview of the software programming choices available and a quick reference to source codes examples that can help you be better oriented to programming. After following the instructions given in Chapter 2, it is hoped that you feel comfortable enough to proceed further.

Programming choices for DAS cards: You may use Advantech application software such as Advantech DLL driver. On the other hand, advanced users are allowed another option for register-level programming, although not recommended due to its laborious and time-consuming nature.

4.1 Programming Choices

DLL Driver

The Advantech DLL Drivers software is included on the companion CD-ROM at no extra charge. It also comes with all the Advantech DAS cards. Advantech's DLL driver features a complete I/O function library to help boost your application performance. The Advantech DLL driver for Windows 95/98/NT works seamlessly with development tools such as Visual C++, Visual Basic, Inprise C++ Builder and Inprise Delphi.

Register-level Programming

Register-level programming is reserved for experienced programmers who find it necessary to write codes directly at the level of device registers. Since register-level programming requires much effort and time, we recommend that you use the Advantech DLL drivers instead. However, if register-level programming is indispensable, you should refer to the relevant information in Appendix C, Register Structure and Format, or to the example codes included on the companion CD-ROM.

4.2 DLL Driver Programming Roadmap

This section will provide you a roadmap to demonstrate how to build an application from scratch using Advantech DLL driver with your favorite development tools such as Visual C++, Visual Basic, Delphi and C++ Builder. The step-by-step instructions on how to build your own applications using each development tool will be given in the *DLL Drivers Manual*. Moreover, a rich set of example source codes are also given for your reference.

Programming Tools

Programmers can develop application programs with their favorite development tools:

- Visual C++**
- Visual Basic**
- Delphi**
- C++ Builder**

For instructions on how to begin programming works in each development tool, Advantech offers a *Tutorial* Chapter in the *DLL Drivers Manual* for your reference. Please refer to the corresponding sections in this chapter on the *DLL Drivers Manual* to begin your programming efforts. You can also take a look at the example source codes provided for each programming tool, since they can get you very well-oriented.

The *DLL Drivers Manual* can be found on the companion CD-ROM. Or if you have already installed the DLL Drivers on your system, The *DLL Drivers Manual* can be readily accessed through the **Start** button:

Start/Programs/Advantech Driver for 95 and 98 (or for NT)/Driver Manual

The example source codes could be found under the corresponding installation folder such as the default installation path:

\\Program Files\\Advantech\\ADSAPI\\Examples

For information about using other function groups or other development tools, please refer to the *Creating Windows 95/NT Application with DLL Driver* chapter and the *Function Overview* chapter on the *DLL Drivers Manual*.

Programming with DLL Driver Function Library

Advantech DLL driver offers a rich function library to be utilized in various application programs. This function library consists of numerous APIs that support many development tools, such as Visual C++, Visual Basic, Delphi and C++ Builder.

According to their specific functions or services, those APIs can be categorized into several function groups:

- Analog Input Function Group**
- Analog Output Function Group**
- Digital Input/Output Function Group**
- Counter Function Group**
- Temperature Measurement Function Group**
- Alarm Function Group**
- Port Function Group**
- Communication Function Group**
- Event Function Group**

For the usage and parameters of each function, please refer to the *Function Overview* chapter in the *DLL Drivers Manual*.

Troubleshooting DLL Driver Error

Driver functions will return a status code when they are called to perform a certain task for the application. When a function returns a code that is not zero, it means the function has failed to perform its designated function. To troubleshoot the DLL driver error, you can pass the error code to **DRV_GetErrorMessage** function to return the error message. Or you can refer to the *DLL Driver Error Codes* Appendix in the *DLL Drivers Manual* for a detailed listing of the Error Code, Error ID and the Error Message.

5. Principles of Operation

This chapter describes the analog input, analog output, digital I/O and counter/timer features of the PCI-1712/1712L card.

5.1 Analog Input Features

This section describes the following features of the analog input (A/D) of PCI-1712/1712L card:

- ◆ Analog input ranges and gains
- ◆ Analog input acquisition modes
- ◆ A/D sample clock sources
- ◆ Trigger sources
- ◆ Analog Input Data Format

Analog Input Ranges and Gains

Each channel on the PCI-1712/1712L can measure unipolar and bipolar analog input signals. A unipolar signal can range between 0 to 10 V FSR, while a bipolar signal extends within ± 10 V FSR.

The PCI-1712/1712L is able to set different input ranges for each channel. When the channels are set as unipolar or bipolar input in FSR, the sampling rate can be up to 600 kS/s, but when there is a mixed combination of unipolar and bipolar inputs, it can operate only with a rate up to 400 kS/s.

The PCI-1712/1712L also provides various gain levels that are programmable per channel. Table 5-1 lists the effective ranges supported by the PCI-1712/1712L using these gains.

Table 5-1: Gains and Analog Input Range

Gain	Unipolar Analog Input Range	Bipolar Analog Input Range
0.5	N/A	± 10 V
1	0 ~ 10 V	± 5 V
2	0 ~ 5 V	± 2.5 V
4	0 ~ 2.5 V	± 1.25 V
8	0 ~ 1.25 V	± 0.625 V

For each channel, choose the gain level that provides most optimal range that can accommodate the signal range you have to measure. For detailed information, please refer to Appendix D.5 A/D Channel Range Setting.

Analog Input Acquisition Modes

The PCI-1712/1712L can acquire data in single value, pacer, post-trigger, delay-trigger, about-trigger and pre-trigger acquisition modes. These analog input acquisition modes are described in more detail in the followings:

❑ Single Value Acquisition Mode

The single value acquisition mode is the simplest way to acquire data. Once the software issues a trigger command, the A/D converter will convert one data, and return it immediately. User can check the A/D FIFO status (A/D_F/E on Read BASE+8) to make sure if the data is ready to be received. For detailed information, please refer to Appendix D.9 Interrupt and FIFO status.

❑ Pacer Acquisition Mode

Use pacer acquisition mode to acquire data if you want to accurately control the time interval between conversions of individual channels in a scan. A/D conversion clock comes from A/D counter or external AI_CLK on connector. A/D conversion starts when the first clock signal comes in, and will not stop if the clock is still continuously sending into it. Conversion data is put into the A/D FIFO. For high-speed data acquisition, you have to use the DMA data transfer for analog input to prevent data loss.

❑ Post-Trigger Acquisition Mode

Post-trigger allows you to acquire data based on a trigger event. Post-trigger acquisition starts when the PCI-1712/1712L detects the trigger event and stops when the preset number of post-trigger samples has been acquired or when you stop the operation. This trigger mode must work with the DMA data transfer mode enabled.

Use post-trigger acquisition mode when you want to acquire data when a post-trigger event occurs. Please specify the following parameters when using software in post-trigger acquisition mode:

- ◆ Set to Post-Trigger Acquisition Mode
- ◆ The A/D sample clock source and sampling rate
- ◆ The trigger source and edge type
- ◆ The acquired sample number N

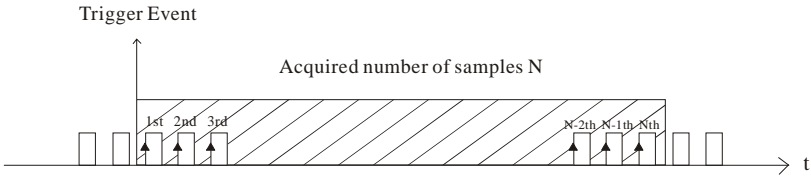

Figure 5-1: Post-Trigger Acquisition Mode

□ Delay Trigger Acquisition Mode

In delay trigger mode, data acquisition will be activated after a preset delay number of sample has been taken after the trigger event. The delay number of sample ranges from 2 to 65535 as defined in DMA counter.

Delay-trigger acquisition starts when the PCI-1712/1712L detects the trigger event and stops when the specified number of A/D samples has been acquired or when you stop the operation. This triggering mode must work with the DMA data transfer mode enabled

Please specify the following parameters when using software in delay trigger mode:

- ◆ Set to Delay-Trigger Acquisition Mode
- ◆ The sample clock source and sampling rate
- ◆ The trigger source and edge type
- ◆ The acquired sample number N
- ◆ The sample number M delays after the delay-trigger event happened

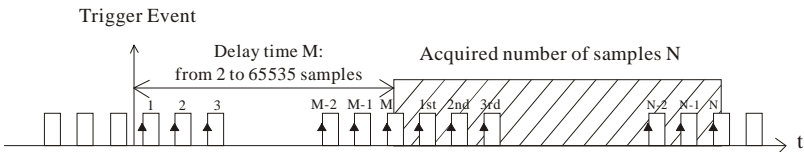

Figure 5-2: Delay-Trigger Acquisition Mode

□ About Trigger Acquisition Mode

Use about-trigger acquisition mode when you want to acquire data both before and after a specific trigger event occurs. This operation is equivalent to doing both a pre-trigger and a post-trigger acquisition.

When using software, please specify the following parameters, when using software in About-Trigger acquisition mode:

- ◆ Set to About-Trigger Acquisition Mode
- ◆ The sample clock source and sample rate
- ◆ The trigger source and edge type
- ◆ The total acquired sample number N
- ◆ The specific sample number M before the trigger event. The range of preset sample number is 2 samples minimum and is limited on basis of memory size of your host PC.

In about-trigger mode, users must first designate the size of the allocated memory and the amount of samples to be snatched after the trigger event happens. The about-trigger acquisition starts when the first clock signal comes in. Once a trigger event happens, the on-going data acquisition will continue until the designated amount of samples have been reached. When the PCI-1712/1712L detects the selected about-trigger event, the card keeps acquiring the preset number of samples, and kept the total number of samples on the FIFO.

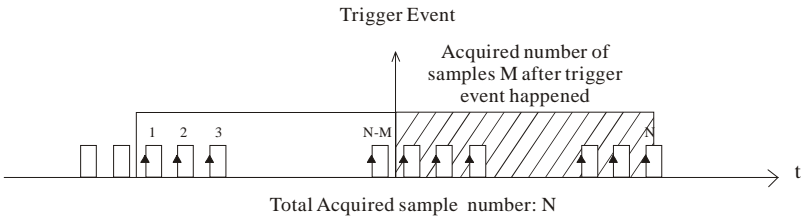

Figure 5-3: About-Trigger Acquisition Mode

□ Pre-Trigger Acquisition Mode

Pre-Trigger mode is a particular application of about-trigger mode. Use pre-trigger acquisition mode when you want to acquire data before a specific trigger event occurs. Pre-trigger acquisition starts when you start the operation and stops when the trigger event happens. Then the specific number of samples will be reversed in the FIFO before the pre-trigger event occurred. Please specify the following parameters, when using software in Pre-trigger acquisition mode:

- ◆ Set to Pre-Trigger Acquisition Mode
- ◆ The sample clock source and sample rate
- ◆ The trigger source and gate type
- ◆ Assume the total acquired sample number is N, then set the total sample number to be N+2.

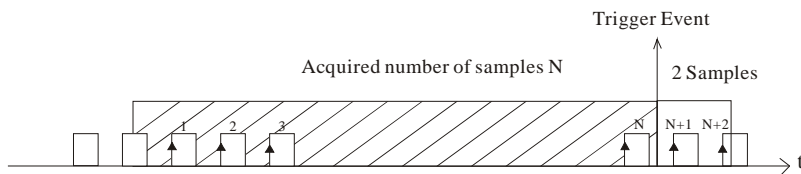

Figure 5-4: Pre-Trigger Acquisition Mode

A/D Sample Clock Sources

The PCI-1712/1712L can adopt both internal and external clock sources for pacer, post-trigger, delay-trigger, about-trigger acquisition modes:

- ◆ Internal A/D sample clock with 16-bit Counter
- ◆ External A/D sample clock that is connected to AI_CLK on the PCLD-8712 screw terminal board.

The internal and external A/D sample clocks are described in more detail as follows.

□ Internal A/D Sample Clock

The internal A/D sample clock uses a 10 MHz time base. Conversions start on the rising edge of the counter output. You can use software to specify the clock source as internal and the sampling frequency to pace the operation. The minimum frequency is 152.6 S/s, the maximum frequency is 2 MS/s. According to the sampling theory (Nyquist Theorem), you must specify a frequency that is at least twice as fast as the input's highest frequency component to achieve a valid sampling. For example, to accurately sample a 20 kHz signal, you have to specify a sampling frequency of at least 40 kHz. This consideration can avoid an error condition often known as aliasing, in which high frequency input components appear erroneously as lower frequencies when sampling.

□ External A/D Sample Clock

The external A/D sample clock is useful when you want to pace acquisitions at rates not available with the internal A/D sample clock, or when you want to pace at uneven intervals. Connect an external A/D sample clock to screw terminal AI_CLK on the PCLD-8712 screw terminal board. Conversions will start on the rising edge of the external A/D sample clock input signal. You can use software to specify the clock source as external. The sampling frequency is always limited to a maximum of 2 MHz for the external A/D sample clock input signal.

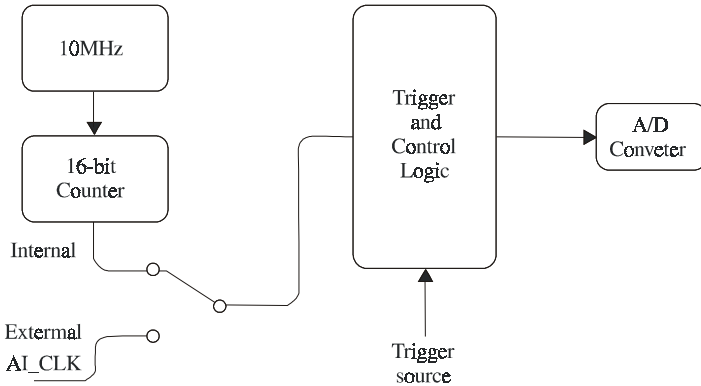

Figure 5-5: PCI-1712/1712L Sample Clock Source

Trigger Sources

The PCI-1712/1712L supports the following trigger sources for post-, delay-, about- and pre-trigger acquisition modes:

- ◆ Software trigger,
- ◆ External digital (TTL) trigger, and
- ◆ Analog threshold trigger.

With PCI-1712/1712L, user can define the type of trigger source as rising-edge or falling-edge. These following sections describe these trigger sources in more detail.

❑ Software Trigger

A software trigger event occurs when you start the analog input operation (the computer issues a write to the board to begin acquisitions). When you write the value to analog input trigger flag AI_TRGF on Write BASE+6 to produce either a rising-edge or falling-edge trigger, depending upon the trigger source type you choose. This edge will then act as an A/D trigger event. For detailed information, please refer to Appendix D.7 A/D Control/Status Register.

❑ External Digital (TTL) Trigger

For analog input operations, an external digital trigger event occurs when the PCI-1712/1712L detects either a rising or falling edge on the External A/D TTL trigger input signal from screw terminal AI_TRG on

the PCLD-8712 screw terminal board. The trigger signal is TTL-compatible.

□ Analog Threshold Trigger

For analog input operations, an analog trigger event occurs when the PCI-1712/1712L detects a transition from above a threshold level to below a threshold level (falling edge), or a transition from below a threshold level to above a threshold level (rising edge). User should connect analog signals from external device or internal analog output channel on board to external screw terminal ANA_TRG on the PCLD-8712 screw terminal board.

On the PCI-1712/1712L, the threshold level is set using a dedicated 8-bit DAC; the hysteresis is fixed at 50 mV. Using software, you can program the threshold level by writing a voltage value to this DAC; this value can range from -10 V to +10 V.

Analog Input Data Format

Table 5-2: Analog Input Data Format

A/D code		Mapping Voltage	
Hex.	Dec.	Unipolar	Bipolar
000h	0d	0	-FS/2
7FFh	2047d	FS/2 - 1 LSB	-1 LSB
800h	2048d	FS/2	0
FFFh	4095d	FS - 1 LSB	FS/2 - 1 LSB
1 LSB		FS/4096	FS/4096

Table 5-3: The corresponding Full Scale values for various Input Voltage Ranges

Gain	Uniplar		Bipolar	
	Range	FS	Range	FS
0.5	N/A	N/A	± 10 V	20
1	0 ~ 10 V	10	± 5 V	10
2	0 ~ 5 V	5	± 2.5 V	5
4	0 ~ 2.5 V	2.5	± 1.25 V	2.5
8	0 ~ 1.25 V	1.25	± 0.625 V	1.25

5.2 Analog Output Features

The PCI-1712 card provides two 12-bit multi-range analog output (D/A) channels. This section describes the following features of the D/A functions:

- ◆ Analog output ranges
- ◆ Analog output operation modes
- ◆ D/A output clock sources
- ◆ Trigger sources
- ◆ Analog Output Data Format

Analog Output Ranges

The PCI-1712 provides two 12-bit analog output channels, both of which can be configured to be applicable within 0 ~ 5 V, 0 ~ 10 V, ± 5 V, ± 10 V output voltage range. On the other hand, users can use external reference voltage of 0 ~ x V or $\pm x$ V output voltage range, where the value of x is from -10 to +10. Users can configure the output range during driver installation or in software programming.

Analog Output Operation Modes

The PCI-1712 can output data in single value, continuous output operation mode. These analog output operation modes are described in more detail in the following sections:

Single Value Operation Mode

The single value conversion mode is the simplest way for analog output operation. Users can define each channel as single output conversion mode. Then users just need to use software to write output data to specific I/O register. The analog output channels will output the corresponding voltage immediately. In the single value operation mode, users need not set any clock source and trigger source, but only output voltage range.

Continuous Output Operation Mode

In continuous output operation mode, users can accurately control the update rate (up to 1 MS/s with DMA data transferring) between conversions of individual analog output channels, and takes full advantage of the PCI-1712. In this mode you can specify a clock source and trigger source and either of the two analog output channels to work in continuous output operation mode. But when both of them operate in this mode, the maximum update rate will be 500 kS/s for each

channel.

In this mode, users need to set the clock source and trigger source first, and then generate the output data to be stored in the memory buffers of host PC. The host computer then transfers those data to be written to the DACs from its buffers to the 32K-sample Output FIFO on board. When it detects a trigger, the board outputs the values in the Output FIFO to the DACs at the same time. When the samples in FIFO decreases to less than half size (i.e. 16K samples) of the FIFO, then the card will send a interrupt request to the host PC, which in turn sends 16K samples to the FIFO. This output operation will repeat until either all the data is sent from the buffers or until you stop the operation.

If the two D/A channels are both operating in continuous output mode, the data in FIFO will be sent in an interlaced manner, i.e. The “even” samples in the FIFO are sent to D/A channel 0, while the “odd” samples to D/A channel 1.

❑ Waveform Output Operation Mode

Waveform output operation mode is a particular and useful application of continuous output operation mode. In this mode, users can output the user-defined waveform pattern repetitively and continuously. Before this operation can begin, users have to use software to allocate the buffer memory and define the waveform pattern first. Then the host computer will transfer the waveform pattern from its buffer allocated in computer memory into the Output FIFO on the board, which in turn will transfer the waveform pattern to the DACs. When the trigger event occurs, each D/A channel running continuous output operation mode will output waveform pattern from FIFO in specific clock rate.

D/A Output Clock Sources

The PCI-1712 can adopt both internal and external clock sources for pacing the analog output of each channel:

- ◆ Internal D/A output clock with 16-bit Counter
- ◆ External D/A output clock that is connected to AO_CLK on the PCLD-8712 screw terminal board

The internal and external D/A output clocks are described in more detail as follows:

❑ Internal D/A Output Clock

The internal D/A output clock uses a 10 MHz time base. Conversions start on the rising edge of the counter output. Through software to specify the clock source as internal and the clock frequency to pace

the analog output operation. The minimum frequency is 156.2 S/s, the maximum frequency is 1 MS/s.

❑ External D/A Output Clock

The external D/A output clock is useful when you want to pace analog output operations at rates not available with the internal D/A output clock, or when you want to pace at uneven intervals, or when you want to start pacing on an external trigger event. Connect an external D/A output clock to screw terminal AO_CLK on the PCLD-8712 screw terminal board. Conversions will start on the rising edge of the external D/A output clock signal. You can use software to specify the clock source as external. Subsequently, the clock frequency that of the external D/A output clock input signal from the screw terminal board.

Trigger Sources

The PCI-1712 supports the following trigger sources for continuous output mode:

- ◆ Software trigger,
- ◆ External digital (TTL) trigger

With PCI-1712, user can define the type of trigger source as rising-edge or falling-edge.

The following section describes these trigger sources in more detail.

❑ Software Trigger

A software trigger event occurs when you start the analog output operation (the computer issues a write to the board to begin conversions). When you write the value to analog input trigger flag AO_TRGF on BASE+A to produce either a rising-edge or falling-edge trigger, depending upon the trigger source type you choose. This edge will then act as a D/A trigger event. For detailed information, please refer to Appendix D.7 A/D Control/Status Register.

❑ External Digital (TTL) Trigger

For analog output operations, an external digital trigger event occurs when the PCI-1712 detects either a rising or falling edge on the External D/A TTL trigger input signal from screw terminal AO_TRG on the PCLD-8712 screw terminal board. The trigger signal is TTL-compatible.

Analog Output Data Format

Table 5-4: Analog Output Data Format

D/A code		Mapping Voltage	
Hex.	Dec.	Unipolar	Bipolar
000h	0d	0	-FS/2
7FFh	2047d	FS/2 - 1 LSB	-1 LSB
800h	2048d	FS/2	0
FFFh	4095d	FS - 1 LSB	FS/2 - 1 LSB
1 LSB		FS/4096	FS/4096

Table 5-5: The corresponding Full Scale values for various Output Voltage Ranges

Reference Source	Uniplar		Bipolar	
	Range	FS	Range	FS
Internal	0 ~ 5 V	5	± 5 V	10
	0 ~ 10 V	10	± 10 V	20
External	0 ~ x V	x	$\pm x$ V	2x

5.3 Digital I/O Features

The PCI-1712/1712L supports 16 digital I/O channels. These I/O channels are divided into two bytes: specifically a low byte, DIO0 to DIO7; and a high byte, DIO8 to DIO15. You can use each byte as either an input port or an output port by configuration register; and all eight channels of the byte have the same configuration. For detailed information, please refer to Appendix D.16 Digital I/O configuration registers.

In digital I/O function, you do not need to specify the clock source or trigger source. When you want to output data, you just need to write the data to the digital output channel through software. In the same way, you can use software to read the data from digital input channel.

The default configuration after power on, hardware reset or software reset is to set all the digital I/O channels to logic-low so that users need not worry about damaging external devices during system start up or reset.

5.4 Counter/Timer Features

The PCI-1712/1712L features multifunction counter/timer functions with one-shot, rate generation, frequency measurement and pulse width measurement. There are two 8254 counter chips in PCI-1712/1712L, and each chip has 3 multifunction counters. The first counter chip (chip 1) is specified for AI and AO functions, and can't be used by user. The second counter chip (chip 2) is reserved for user, and the following section describes its features.

The PCI-1712/1712L uses the 82C54 programmable timer/counter chip includes 3 independent 16-bit down counters: counter 0, counter 1 and counter 2. Each counter has clock input, gate input and pulse output. It can be programmed to count from 2 up to 65535.

For detailed information, Intel® 82C54 User's Manual is available by accessing the following path on CD-ROM:

\\Document\Intel 82C54 manual.pdf

Clock sources

The following clock sources are available for the user counters, and they are available to set its active edge as rising edge or falling edge:

Internal clock

User can specify the internal clock as the clock source through software, and choose among four frequency options: 10MHz, 1MHz, 100kHz and 10kHz of the on-board crystal oscillator. For detailed information, please refer to Appendix D.14 Counter gate and clock control/status.

External clock

The external clock is useful when you want to pace counter/timer operations at rates not available with the internal clock or if you want to pace at uneven internals. User can specify an external clock as the clock source through software. User could connect the external clock to the PCI-1712/1712L through the PCLD-8712 screw-terminal wiring board that corresponds to each counter/timer.

Internally cascaded clock

You can also route the clock output signal from one user counter to the clock input signal of the next user counter to internally cascade the counters. In this way, you can create a 32-bit or even a 48-bit counter without externally cascading multiple counters together. When user wants to cascade the counters, please follow the round-robin order of

0, 1 and 2. You can choose any counter to be your first cascaded counter, and the next counter would be the next one in the round-robin order. For example, if you would like to cascade two 16-bit counters into one 32-bit counter, and you choose counter 1 to be the first counter then the next counter you choose should be counter 2.

Gate Types and Sources

The gate types and sources you select determine what kind of gate input signal to enable your counter/timer when receiving clock input. If the external gate input signal comes in either as logic-low or logic-high as you have preset, the counter/timer function is enabled, waiting only for the clock input signal to start counting. The PCI-1712/1712L provides two gate input types, for which user can set easily through software or write to bit GPn on register Base+20 to 24:

Logic-low external gate input:

Enables a counter/timer operation when the external gate signal is logic-low, and disables the counter/timer operation when the external gate signal is logic-high.

Logic-high external gate input:

Enables a counter/timer operation when the external gate signal is logic-high and disables the counter/timer operation when the external gate signal is logic-low.

The gate sources are described as below:

Software Gate:

User can use software to generate the signal to be counter's gate input. It helps user to control counter easily through software.

Previous Counter Output:

User can use previous counter's output as your gate source. The previous counter of counter 0 is counter 2, of counter 1 is counter 0 and of counter 2 is counter 1.

External Gate Source:

User can connect an external gate signal to screw terminal CNTn_GATE on the PCLD-8712 screw terminal board, where n is the counter number.

Counter/timer operation modes

We enhance the gate function for more applications. For example, event counting, rate generation, one shot, frequency measurement and pulse width measurement. We make some innovative arrangements of clock and gate of counter. For detailed information, please refer to Appendix D.12 to D.14 and Intel® 82C54 User's Manual. The following sections show how to implement counter functions.

□ Event counting

The event counting function helps user count events from the counter's associated clock input source.

Each counter features 16-bit, and therefore you can count a maximum of 65,535 events before the counter overflows and returns to 0. If you need wider range for event counting, you can use a cascaded 32-bit counter for counting up to 4,294,967,296 events.

Please follow the procedure below when using software:

1. Select a counter (e.g. counter 0) to do event counting.
2. Set the counter in mode 0 (Please refer to Intel® 82C54 User's Manual).
3. Connect the pin CNT0_CLK of the counter to the event signal source.
4. Set the gate type of the counter to positive (logic-high).
5. Reset the counter to 65,535.
6. Pull high the gate input, and then start down counting.
7. After event counting is finished, read the value from the counter.
8. Calculate the number of events.

For example, if the reset value of counter is 65,535 and the read back value is 43930, then the number of events is 65535 minus 43930 and thus equals 21605.

□ Rate generation

The rate generation function helps user generate a continuous pulse output signal from the counter. User can use it as an external clock to output signal to pace other operations, such as analog input, analog output, or other counter/timer operations.

The frequency of input clock and the number of the counter determine the period of the output pulse. If you are using one counter (not cascaded), you can output pulses with a maximum frequency of 5MHz. In rate generation mode, either the internal or external clock source is

appropriate depending on your application.

Please follow the procedure below when using software:

1. Select a counter (e.g. counter 0) to do rate generation.
2. Set the counter in mode 3 (Please refer to Intel® 82C54 User's Manual).
3. Select the clock input of the counter. (Could be internal or external)
4. Set the gate type of the counter to positive (logic-high).
5. Set the value of the counter to serve as the factor with which to divide the clock input frequency.
6. Pull high the gate input and start rate generation.

For example, if the value of counter is 20 and the clock input frequency is 1 MHz. Then the clock output frequency is $1 \text{ MHz} / 20 = 50 \text{ KHz}$.

One shot

Use one-shot mode to generate a single pulse signal from the counter, which is triggered by the gate input signal.. You can use this pulse output signal as an external digital (TTL) trigger source to start other operations, such as analog input or analog output operations. When the one-shot operation is triggered, only a single pulse is output. The output pulse is always a negative pulse, whose width is determined by the clock input signal and the value of the counter.

Please follow the procedure below when using software:

1. Select a counter to do one shot.
2. Set the counter in mode 1 (Please refer to Intel® 82C54 User's Manual).
3. Select the clock source of the counter. (Could be internal or external)
4. Set the gate type of the counter to positive (logic-high).
5. Set the value of the counter to serve as the factor with which to multiply the clock input period.
6. Pull high the gate input and start to do one-shot output.

For example, if the value of counter is 20 and the frequency of clock source is 1MHz, the period of the one-shot output source is $20 / 1 \text{ MHz} = 20 \text{ ms}$.

□ Frequency measurement

The frequency measurement function helps user to measure the frequency of the signal from counter-associated clock input on PCLD-8712.

Frequency measurement needs two counters to implement. Use the first counter to produce a one-shot pulse with defined pulse period to be the second counter's gate. Connect the signal source, whose frequency is to be measured, to the clock input of the second counter. Since the one-shot pulse generated from the first counter is always a negative pulse, we have to set the gate input type of the second counter as logic low for proper frequency measurement.

The second counter starts to count once the gate is set to low and stops when the gate is high again after a period of time. Assume the measured frequency signal is the regular pulse, then we can calculate its frequency by the period of one-shot and the value of second counter.

Please follow the procedure below when using software:

1. Select the first counter to do one shot and specify its pulse period.
2. Connect the signal output CNT1_OUT of the first counter to the second counter's gate input CNT2_GATE.
3. Select the clock source of the first counter. (Could be internal or external)
4. Set the gate type of the first counter to positive (logic-high), and the second counter to negative (logic-low).
5. Reset the second counter to 65,535.
6. Pull high the gate input of the first counter and start to do frequency measurement.
7. Read the value of the second counter.
8. Evaluate the frequency of the measured pulse.

For example, if frequency measurement is done with the second counter value set at 65,535 and the period of one-shot from the first counter set at 0.1 sec, then the value of the second counter we get back is 43930. Thus, the frequency of measured pulse could be calculated as $(65535-43930)/0.1\text{sec.} = 216050 \text{ Hz}$.

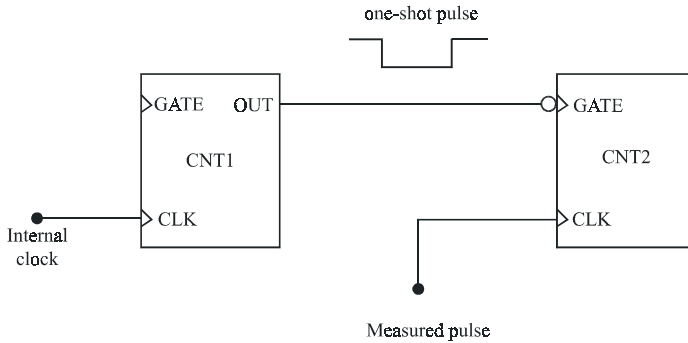

Figure 5-6: Frequency measurement

The following C program serves as an example to explain how to implement the frequency measurement by software.

```

    outport(addr2_1712+0x26,0x03);    // Set internal clock as 10 KHz
    while(!kbhit())
    {
//Initialize CNT1 and CNT2
        outport(addr2_1712+0x24,0x00);
        outport(addr2_1712+0x22,0x00);

//Setup CNT1 to output 1 sec. pulse in One-Shot mode
        outport(addr2_1712+0x1e,0x72);    //CNT1 82C54 mode 1
        outport(addr2_1712+0x1a,0x10);    //Set CNT1 low byte
        outport(addr2_1712+0x1a,0x27);    //Set CNT1 high byte
/*CNT1 generate the pulse with 1 sec. period (10KHz/ 10,000 pulse=1
    Hz)*/

/*Setup CNT2 to count the event of external measured clock signal
during one-shot //pulse from CNT1*/
        outport(addr2_1712+0x1e,0xb0);    //CNT2 82C54 mode 0
        outport(addr2_1712+0x1c,0xff);    //Set CNT2 low byte
        outport(addr2_1712+0x1c,0xff);    //Set CNT2 high byte
    }

```

```
//Set the value of CRT2 as 65,535 for down counting
output(addr2_1712+0x24,0x80); //Set CNT2's gate input as high
output(addr2_1712+0x24,0x88);
output(addr2_1712+0x24,0x00); /*Generate one clock to CNT2,
and set CNT2's gate input as
low*/

output(addr2_1712+0x24,0x52); /*Set CNT2's clock source as
external from CNT1's OUT, and
negative polarity*/

output(addr2_1712+0x22,0x80); //Set CNT1's gate input as high
output(addr2_1712+0x22,0x88);
output(addr2_1712+0x22,0x80); //Generate one clock to CNT1
output(addr2_1712+0x22,0x81); //Set CNT1's clk source as
//internal

//Check if CNT2's gate and clock are in logic-high status
//It means that if frequency measurement is in progress
while(i != 0x500)
{
    i = inport(addr2_1712+0x24) & 0x0500;
}
//The CNT2 has started to do frequency measurement
//Check if CNT2's gate is in logic-low status
//It checks if frequency measurement is over?
while(1)
{
    i = inport(addr2_1712+0x24) & 0x0100;
    if(i!=0x0100) break;
}
/*The CNT2 has finished the job, and then show the measured
frequency on display*/
dl= inport(addr2_1712+0x1c); //Read low byte
dh= inport(addr2_1712+0x1c)<<8; //Read high byte
dh= dh + (dl & 0x00ff);
old_count = 0xffff - dh ;
```

```
printf("Counter 2 = %u \n",old_count);
old_count = 0;
}
```

□ Pulse width measurement

The pulse width measurement function helps user measure the period of the signal from counter-associated clock input on PCLD-8712.

Pulse width measurement also needs two counters to implement. Use the first counter to measure the positive period of the pulse and second counter to measure the negative period of the pulse (In DLL driver, it uses CNT1 and CNT2 to implement the pulse width measurement function). To implement the function, we have to connect the measured pulse signal to the gate of the two counters, and the same clock source to the clock of the two counters.

Please follow the procedure below when using software:

1. Select the two counters to do event counting.
2. Set both counters in mode 0 (Please refer to Intel® 82C54 User's Manual).
3. Connect the measured pulse signal source to pin CNT1_GATE and CNT2_GATE of both counters
4. Select the clock source of the counter. (Could be internal external)
5. Connect the clock source to pin CNT1_CLK and CNT2_CLK of both counters.
6. Set the gate type of the first counter to negative (logic-low).
7. Set the gate type of the second counter to positive (logic-high).
8. Reset both counters to 65,535 and the counters now are ready for pulse width measurement.
9. On the first incoming pulse, each counter will start measuring specifically the positive and negative period of the first pulse cycle.
10. Read the value of both counters.
11. Calculate the width of measured pulse.

For example, if the clock source is of 1KHz, and the reset value of both counters set to 65,535, then we get a value of 40000 for the first counter, and 50000 for the second counter. Thus the negative pulse period is $(65535-40000)/1K=25.535$ sec, and the positive pulse period is

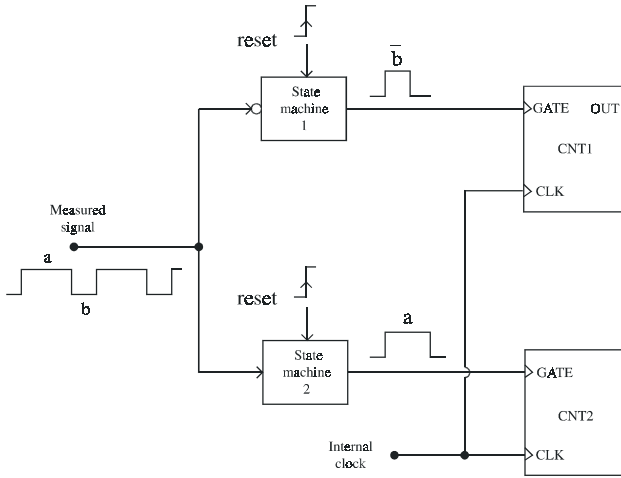

$$(65535-50000)/1K = 15.535 \text{ sec.}$$

Figure 5-7: Pulse width measurement

The following C program is the example to explain how to implement the pulse width measurement by software.

```

output(addr2_1712+0x26,0x00); //Set internal clock as 10 MHz
while(!kbhit())
{
output(addr2_1712+0x1e,0x70); //CNT1 82C54 mode 0
output(addr2_1712+0x1a,0xff); //Set CNT1 low byte
output(addr2_1712+0x1a,0xff); //Set CNT1 high byte

output(addr2_1712+0x1e,0xb0); //CNT2 82C54 mode 0
output(addr2_1712+0x1c,0xff); //Set CNT2 low byte
output(addr2_1712+0x1c,0xff); //Set CNT2 high byte

output(addr2_1712+0x24,0x80); //Set CNT2's gate input as high
output(addr2_1712+0x24,0x88); //Generate one clock to CNT2
output(addr2_1712+0x24,0x31); /*Set CNT2's clock source as

```



```

internal, and gate use for pulse
width measurement*/

output(addr2_1712+0x22,0x80); //Set CNT1's gate input as high
output(addr2_1712+0x22,0x88); //Generate one clock to CNT1
output(addr2_1712+0x22,0x71); /*Set CNT1's clock source as
internal, gate use for pulse width
measurement, and negative
polarity*/

/*Reset pulse width measurement state machine, and check if CNT2's
gate input receives the measured signal*/
while(1)
{
    output(addr2_1712+0x24,0x0031); //Generate a rising edge to
//reset the pulse
    output(addr2_1712+0x24,0x0131); //width measurement state
//machine
    i = inport(addr2_1712+0x24) & 0x0800; /*Check if receiving
measured signal
from gate input of
CNT2*/

    if (i == 0x0800) break ;
}
output(addr2_1712+0x22,0x0071); //Generate a rising edge to reset
//the pulse
output(addr2_1712+0x22,0x0171); //width measurement state
//machine

//CNT2's gate input receiving the measured signal, check if finished
while(1)
{
    i = inport(addr2_1712+0x24) & 0x0800;
    if(i == 0x0000) break; //CNT2's gate input is low
}

```

```
//CNT1's gate input received the measured signal, check if finished?
while(1)
{
i = inport(addr2_1712+0x22) & 0x0800;
if(i == 0x0000) break;           //CNT1's gate input is low
}

/*The CNT1 & 2 has finished the job, and then show the measured
period on display*/
dl= inport(addr2_1712+0x1a);      //Read low byte
dh= inport(addr2_1712+0x1a)<<8;  //Read high byte
dh= dh + (dl & 0x00ff);
neg_count = 0xffff - dh ;
dl= inport(addr2_1712+0x1c);
dh= inport(addr2_1712+0x1c)<<8;
dh= dh + (dl & 0x00ff);
pos_count = 0xffff - dh ;
duty = pos_count;
duty = duty + neg_count;
duty = (pos_count/duty)*100;      //Show the duty ratio of positive
cycle
printf("P+ = %u P- = %u Duty %5.3f\n",pos_count,neg_count,
duty);
neg_count = 0;
pos_count = 0;
}
```

6. Calibration

This chapter provides brief information on PCI-1712/1712L calibration. Regular calibration checks are important to maintain accuracy in data acquisition and control applications. A calibration utility, AutoCali, is included on the companion CD-ROM :

AutoCali.EXE PCI-1712/1712L calibration utility

This calibration utility is designed for the Microsoft®Windows™ environment. Access this program from the default location:

C:\Program Files\Advantech\ADSAPI\Utility\PCI1712

Note:

- ✎ If you installed the program to another directory, you can find these programs in the corresponding subfolders in your destination directory.
-

The PCI-1712/1712L has been calibrated at the factory for initial use. However, a calibration of the analog input and the analog output function every six months is recommended.

6.1 VR Assignment

There is one variable resistor (VR1) on the PCI-1712/1712L to adjust the accurate reference voltage on the PCI-1712/1712L. We have provided a test point (See TP5 in Figure 6-1) for you to check the reference voltage on board. You will need a precise 4½-digit digital multi-meter. Before you start to calibrate A/D and D/A channels, please adjust VR1 until the reference voltage on TP5 has reached +5.0000 V. Figure 6-1 shows the locations of VR1 and TP5.

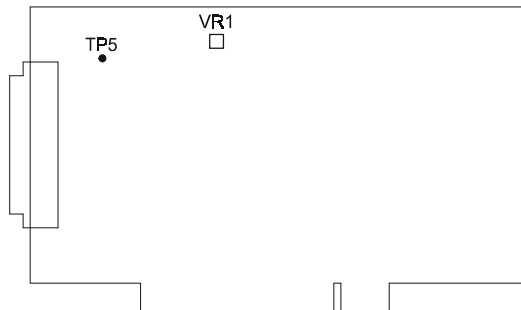

Figure 6-1: PCI-1712/1712L VR1 & TP5

6.2 A/D Calibration

Regular and proper calibration procedures ensure the maximum possible accuracy. It is easy to complete the A/D calibration procedure automatically (i.e. through software calibration) by executing the A/D calibration program AutoCali. Therefore, it is not necessary to adjust the hardware settings of the PCI-1712/1712L. However, the following calibration steps are also provided for your reference in case manual calibration is needed:

1. Adjust VR1 until the reference voltage on TP5 has reached +5.0000 V.
2. Set PCI-1712 to calibration mode, which will configure AI2 to +5 V, and AI0 to 0 V. (Write “1” in AI0_CAL at the register address BASE+6 bif7).
3. Adjust the PGA offset voltage. First, set the analog input voltage range of AI0 to ± 10 V. Adjust the PGA offset register (BASE+2C), and acquire a value from AI0 in single value acquisition mode. Then switch the analog voltage range to ± 1.25 V to repeat the operation in this step again to acquire a value from AI0. Repeat this cycle several times. Meanwhile, adjust the PGA offset voltage until the AI0’s values become the same for both the analog input range ± 10 V and ± 1.25 V.
4. Adjust the gain value of the PGA. First, set the analog input voltage range of AI2 between 0 and 5V. Adjust the gain register (Base+2C), and then acquire the value for AI2 from single value acquisition mode. Adjust the gain value of the PGA until the subsequent AI2’s values converge within the 0x0ffe to 0x0fff range.
5. Adjust the bipolar offset voltage. First, set the analog input range within ± 2.5 V. Adjust the bipolar offset register (Base+2C), and then acquire the code from AI0 from single value acquisition mode. Adjust the bipolar offset voltage until the AI0’s code flickers around 0x0800.
6. Adjust unipolar offset voltage. First, set the analog input range within 0 and 5 V. Adjust the unipolar offset register (Base+2C), and then acquire the code for AI0 from single value acquisition

mode. Adjust the gain until the AIO's value converges between 0 and 1.

7. Repeat steps 4 to 6 several times.

6.3 D/A Calibration

You can select an on-board +5V or +10V *internal reference voltage* or an *external voltage* as your analog output reference voltage. If you use an external reference, connect the reference voltage within the $\pm 10\text{V}$ range to the reference input of the D/A output channel you want to calibrate. Then adjust the gain value, unipolar offset voltage, bipolar offset voltage, respectively, of D/A channels 0 and 1 with the associated register (BASE+2C).

Note:

✎ A precision voltmeter is recommended to calibrate the D/A outputs.

The auto-calibration program AutoCali.EXE helps you finish the D/A calibration procedure automatically. In order to get the maximum possible accuracy of the D/A channels, you need to calibrate the A/D channels first. Although the procedure is not necessary, the following calibration steps are provided below for your reference in case you want to implement the calibration yourself:

1. Calibrate the A/D channels first.
2. Set PCI-1712 in calibration mode. AI4 is connected to AO0 and AI6 is connected to AO1. (Write "1" to the bit, AIO_CAL, on register BASE+6 bit7)
3. Set the unipolar output range of both AO0 and AO1 the same as the internal or external reference voltage range, either 0 to 5V or 0 to 10 V.
4. Set the output value of the AOn (where n=0 or 1) data register at (BASE+0x0C) as 0x0ff e and output to AOn.
5. Adjust the associated gain register (BASE+0x0C) until the AOn output value reads AI4+2n equals 0x0ff e.
6. Set the output value of the AOn data register (BASE+0x0C) as 0x0001 and output to AOn.
7. Adjust the associated unipolar offset register (BASE+0x2C) until

- the AOn output code reads $AI4+2n$ equals 0×0001 .
- 8. Set the bipolar output range of AO0 and AO1 the same as the reference voltage within -10 to +10 V.
- 9. Set the output value of AOn data register (BASE+0x0C) as 0×0800 and output to AOn.
- 10. Adjust the associated bipolar offset register (BASE+0x2C) until the AOn output code reads $AI4+2n$ equals 0×0800 .
- 11. Repeat steps 3 to 10 several times.

6.4 Calibration Utility

The calibration utility, *AutoCali*, provides four functions - auto A/D calibration, auto D/A calibration, manual A/D calibration and manual D/A calibration. The program helps the user to easily finish the calibration procedures automatically; however, the user can calibrate the PCI-1712/1712L manually. Sections 6.2 and 6.3 illustrated the standard calibration procedures for your reference. If you want to calibrate the hardware in your own way, these two sections will guide you.

The following steps will guide you through the PCI-1712/1712L software calibration.

Step 1: Access the calibration utility program *AutoCali.exe* from the default location:

C:\Program Files\Advantech\ADSAPI\Utility\PCI1712

Note:

- ✎ If you installed the program to another directory, you can find this program in the corresponding subfolders in your destination directory.

Step 2: Select PCI-1712/1712L in the ADSDAQ dialog box.

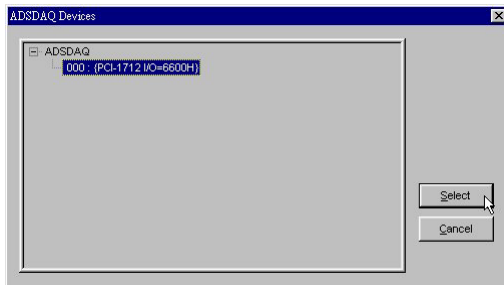

Figure 6-2: Selecting the device you want to calibrate

Step 3: After you start to calibrate the PCI-1712/1712L, please don't forget to adjust VR1.

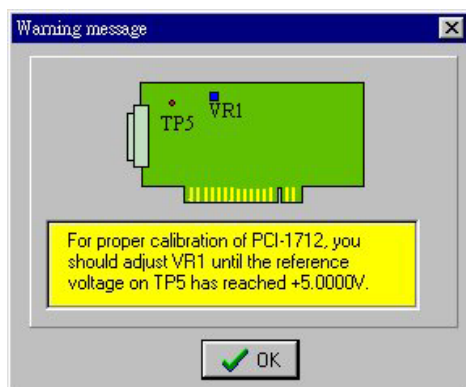

Figure 6-3: Warning message before start calibration

A/D channel Auto-Calibration

Step 4: Click the *Auto A/D Calibration* tab to show the A/D channel auto-calibration panel (Fig. 6-4). Press the start button to calibrate A/D channels automatically.

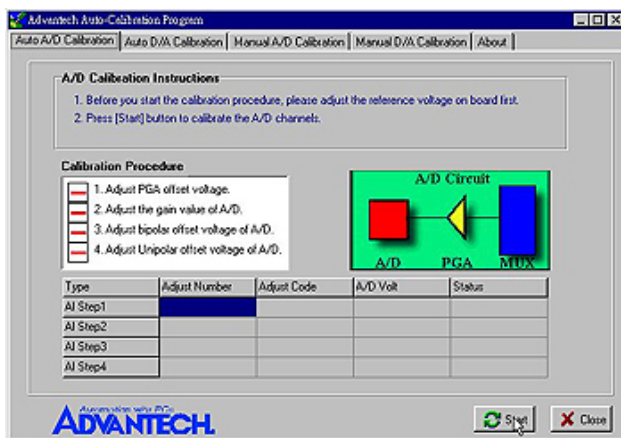

Figure 6-4: Auto A/D Calibration Dialog Box

Step 5: The first A/D calibration procedure is enabled (Fig. 6-5).

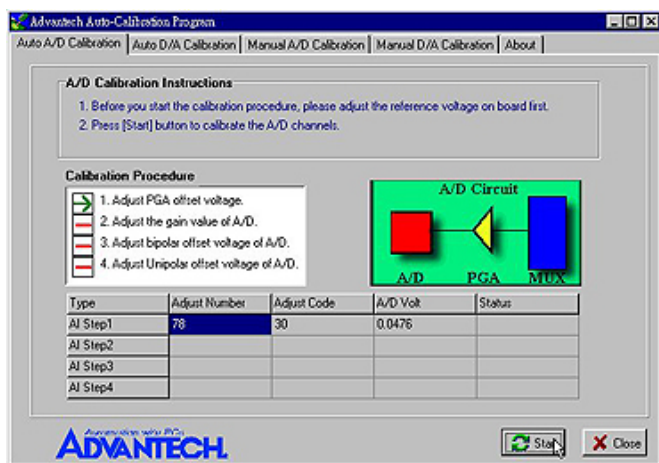

Figure 6-5: A/D Calibration Procedure 1

Step 6: The second A/D calibration procedure is enabled (Fig. 6-6)

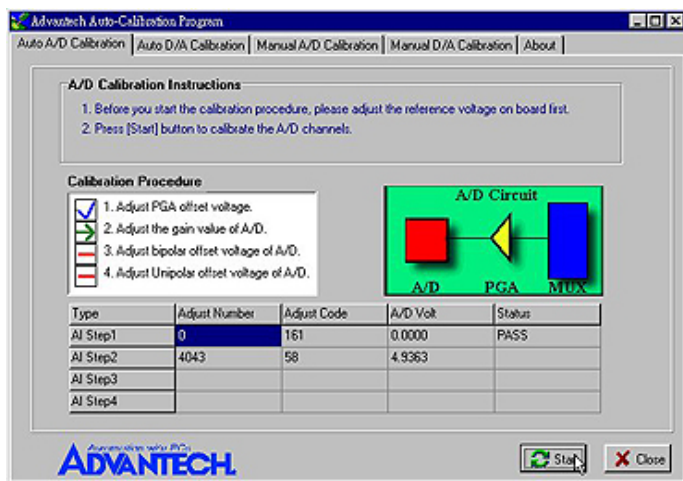

Figure 6-6: A/D Calibration Procedure 2

Step 7: The third A/D calibration procedure is enabled (Fig. 6-7)

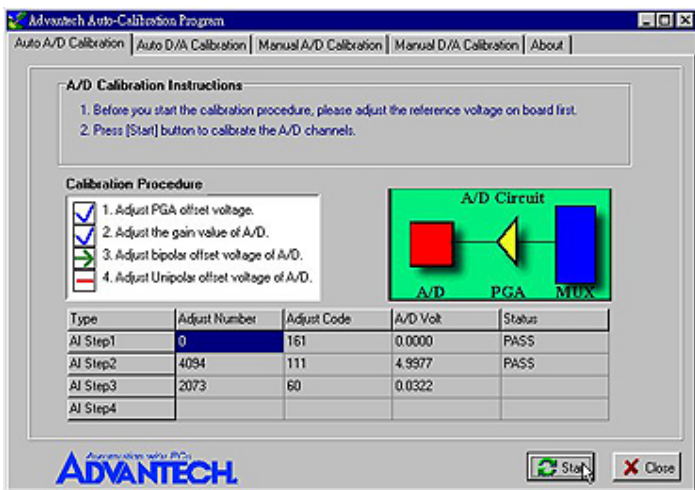

Figure 6-7: A/D Calibration Procedure 3

Step 8: Auto-calibration is finished. (See fig. 6-8)

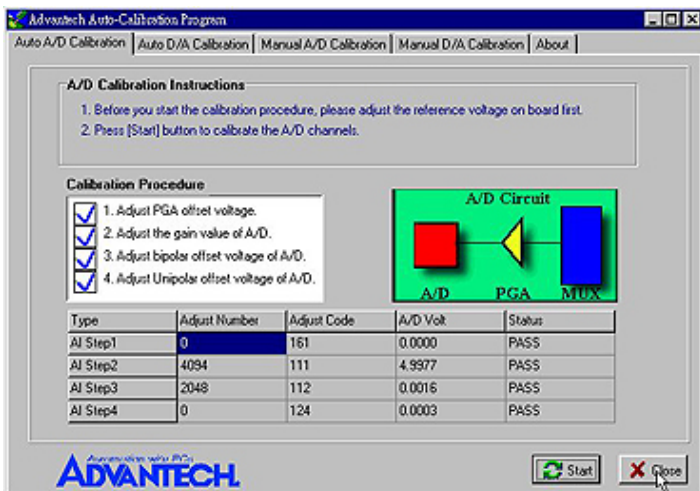

Figure 6-8: A/D Calibration is finished

D/A channel Auto-Calibration

Step 9: Click the *Auto D/A Calibration* tab to show the D/A channel auto calibration panel. Please finish the A/D calibration procedure first before you start the D/A calibration procedure. There are two D/A channels in PCI-1712; select the output range for each channel and then press the start button to calibrate D/A channels (Fig. 6-9).

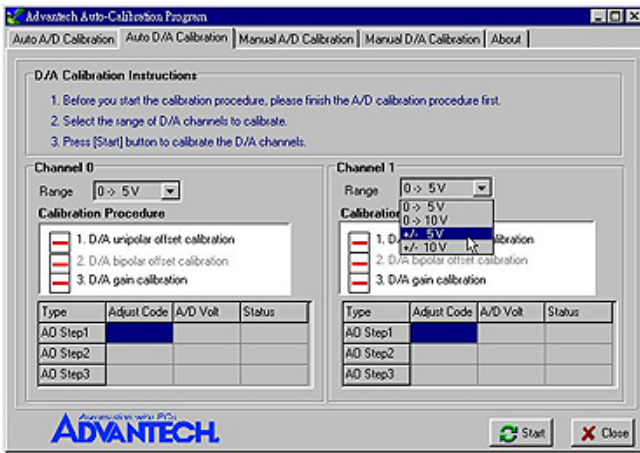

Figure 6-9: Range Selection in D/A Calibration

Step 10: D/A channel 0 calibration is enabled (Fig. 6-10)

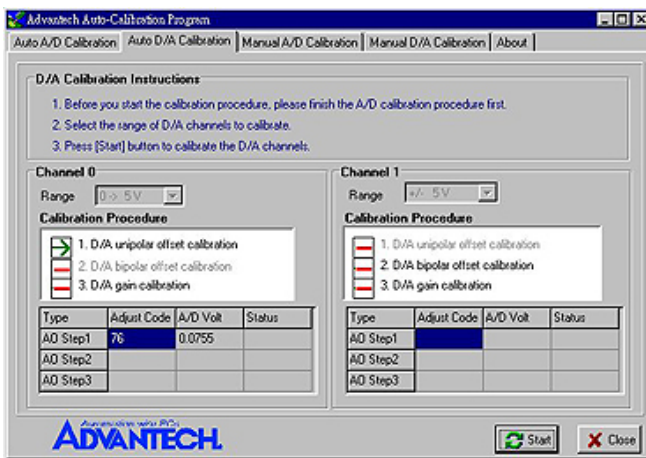

Figure 6-10: Calibrating D/A Channel 0

Step 11: D/A channel 1 calibration is enabled (Fig. 6-11)

Figure 6-11: Calibrating D/A Channel 1

Step 12: Auto-calibration is finished (Fig. 6-12)

Figure 6-12: D/A Calibration is finished

A/D channel Manual-Calibration

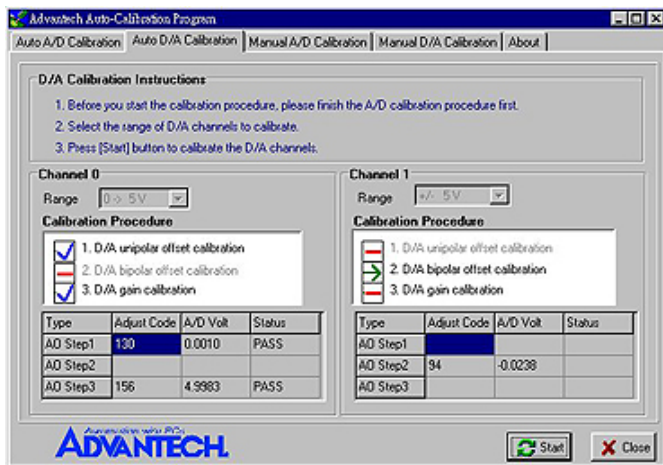
Step 1: Click the *Manual A/D Calibration* tab to show the A/D channel manual calibration panel. Before calibrating, acquire the reference voltage from a precision standard voltage reference. Go to the Range form, select a channel and the target voltage range according to the input voltage value from a precision standard voltage reference(Fig. 6-13).

Note:

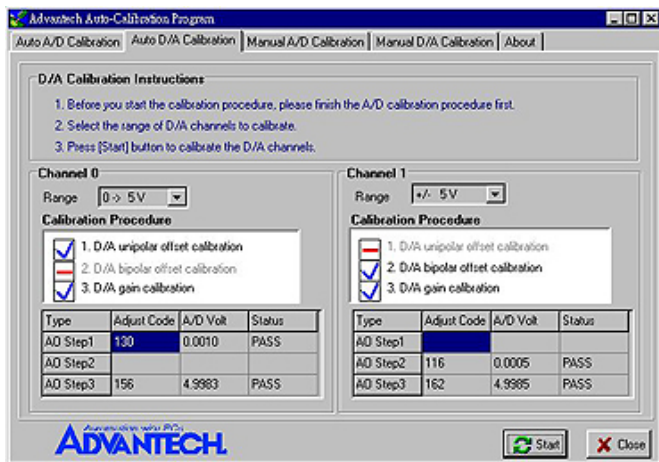
- ✎ The input voltage value you selected from a precision standard voltage reference needs to correspond with the one that the PCI-1712/1712L can read.
- ✎ The input voltage will be analog code so the computer will convert the voltage data into digital code; therefore, the input voltage value you selected from a precision standard voltage reference needs to correspond with the one that the PCI-1712/1712L can read. For example, if the input range is 0 ~ 5V, then input voltage should be 2.9992V not 3V.

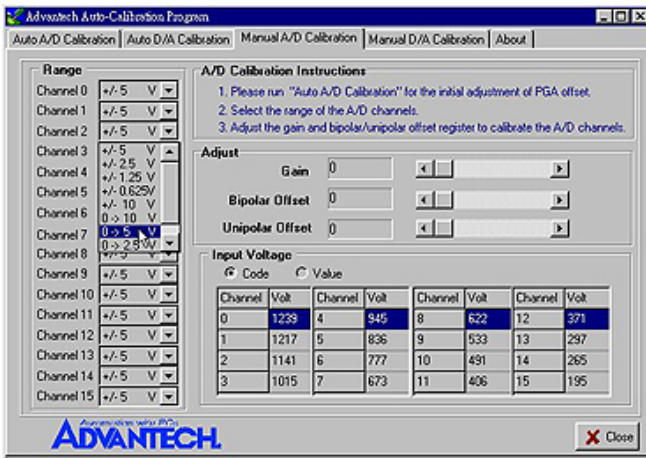

Figure 6-13: Selecting Input Range in Manual A/D Calibration panel

Step 2: According to the difference between reference voltage and receiving data in PCI-1712/1712L, adjust the gain, bipolar offset and unipolar offset registers (Figure 6-14)

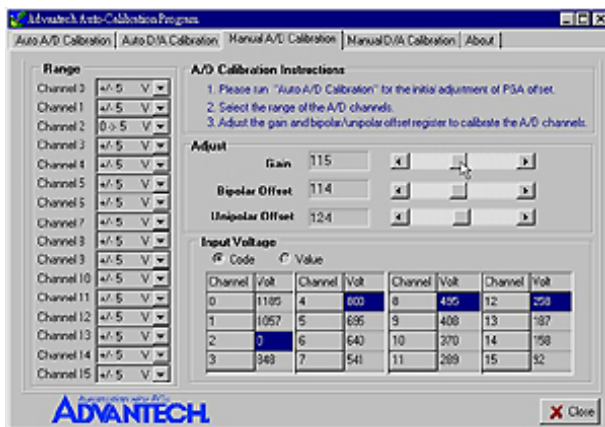

Figure 6-14: Adjusting registers

Step 3: Adjust the registers until they fall between the input voltage from the standard voltage reference and the receiving voltage reflected in the Manual A/D Calibration tab.

D/A channel Manual-Calibration

Step 1: Click the *Manual D/A Calibration* tab to show the D/A channel manual calibration panel. Two D/A channels are individually calibrated. Before calibrating, output desired voltage from the D/A channels and measure it through an external precision multimeter.

Step 2: For example, choose channel 0; select the Range and select the wished output voltage code or value from the radio buttons (Fig. 6-15 and Fig. 6-16).

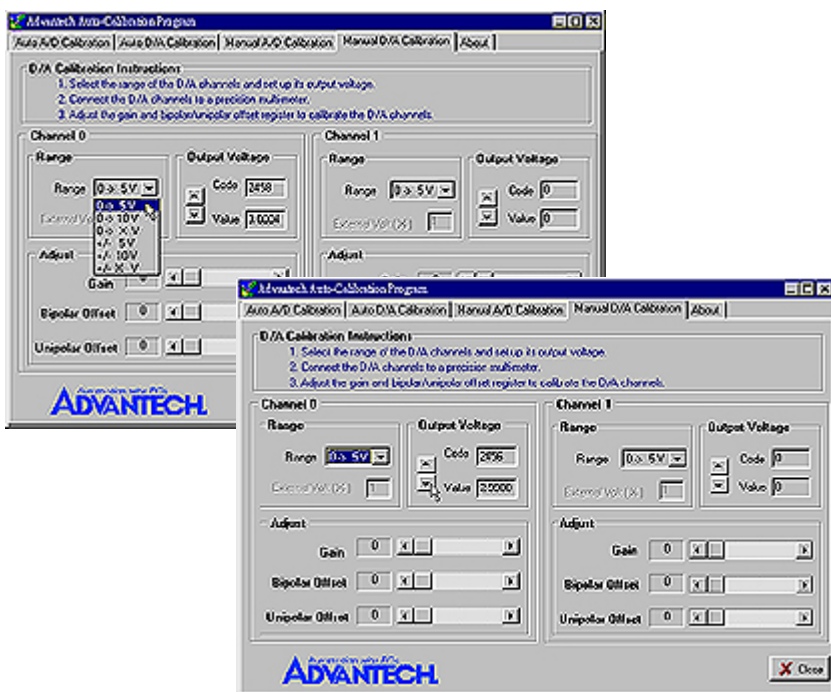

Figure 6-15 & Figure 6-16: Selecting D/A Range and Choosing Output Voltage

Step 3: According to the difference between the output voltage from D/A channel and the value in the multimeter, adjust the gain, bipolar offset and unipolar offset registers (Fig. 6-17)

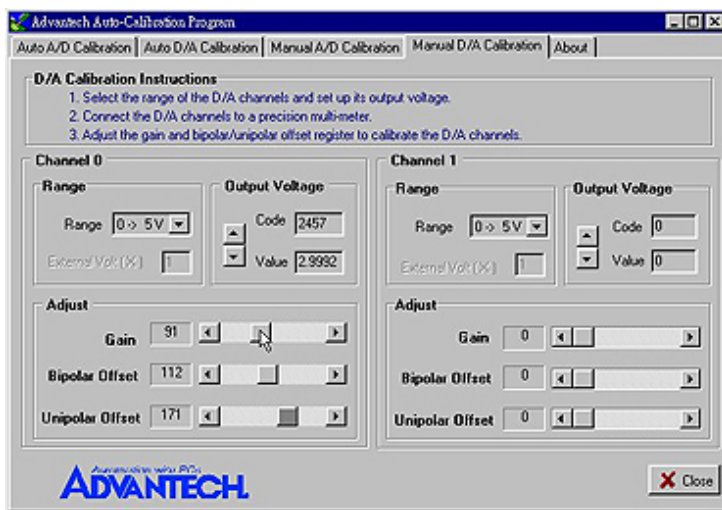

Figure 6-17: Adjusting registers

Step 4: Adjust registers until they fall between the output voltage from the D/A channel and the value in the multimeter.

A. Specification

Analog Input:

Channels	16 single-ended or 8 differential or combination					
Resolution	12-bit					
FIFO Size	1K samples					
Max. Transfer Rate	Multi-channel, single gain: 1 MS/s Multi-channel, multi-gain: 600 kS/s Multi-channel, multi-gain, unipolar/bipolar: 400 kS/s					
Conversion Time	500 ns					
Input range and Gain List	Gain	0.5	1	2	4	8
	Unipolar	N/A	0~10	0~5	0~2.5	0~1.25
	Bipolar	± 10	± 5	± 2.5	± 1.25	± 0.625
Drift	Gain	0.5	1	2	4	8
	Zero($\mu\text{V}/^\circ\text{C}$)	± 80	± 30	± 30	± 30	± 30
	Gain(ppm/ $^\circ\text{C}$)	± 30	± 30	± 30	± 30	± 30
Small Signal Bandwidth for PGA	Gain	0.5	1	2	4	8
	Bandwidth	4.0 MHz	4.0 MHz	2.0 MHz	1.5 MHz	0.65 MHz
Common mode voltage	± 11 V max. (operational)					
Max. Input voltage	± 20 V					
Input Protect	30 V _{p-p}					
Input Impedance	100 M Ω /10pF(Off); 100 M Ω /100pF(On)					
Trigger Mode	Software, on-board programmable pacer or external, pre-trigger, post-trigger, delay-trigger, about-trigger					
Accuracy	DC	DNLE:± 1LSB				
		INLE: ± 1LSB				
		Offset error < 1LSB				
		Gain	0.5	1	2	4
	Gain error (% FSR)	0.15	0.03	0.03	0.05	0.1
	AC	SNR: 68 dB				
		ENOB: 11 bits				
THD: -75 dB typical						
External TTL Trigger Input	Low	0.8 V max.				
	High	2.0 V min.				
External Analog Trigger Input	Range	-10 V to + 10 V				
	Resolution	8-bit				
	Impedance	100 M Ω /100 pF typical				
Clock Output	Low	0.5 V max.@+24 mA				
	High	2.4 V min.@-15 mA				
Trigger Output	Low	0.5 V max.@+24 mA				
	High	2.4 V min.@-15 mA				

Analog Output: (PCI-1712 only)

Channels	2	
Resolution	12-bit	
FIFO Size	32K samples	
Operation mode	Single output, continuous output, waveform output	
Output Range (Internal & External Reference)	Using Internal Reference	0~+5V,0~+10 V, -5~-5V,-10~-+10V
	Using External Reference	0 ~ +x V@ +x V (-10 ≤ x ≤ 10 -x ~ +x V@ +x V (-10 ≤ x ≤ 10)
Accuracy	Relative	± 1 LSB
	Differential Non-linearity	± 1 LSB (monotonic)
Offset	< 1 LSB	
Slew Rate	20V/μs	
Drift	10 ppm/° C	
Driving Capability	± 10mA	
Max. Transfer Rate	Single Channel: 1 MS/s max. for FSR Dual Channel: 500 kS/s max. for FSR	
Output Impedance	0.1Ω max.	
Digital Rate	5 MHz	
Settling Time	2μs(to ±1/2 LSB of FSR)	
External Clock Input	Low	0.8 V max.
	High	2.0 V min.
External TTL Trigger Input	Low	0.8 V max.
	High	2.0 V min.

Digital Input /Output:

Input Channels	16 (bi-directional)	
Number of ports	2	
Input Voltage	Low	0.8 V max.
	High	2.0 V min.
Output Voltage	Low	0.5 V max.@+24 mA (sink)
	High	2.4 V min.@-15 mA (source)

Counter/Timer:

Channels	3	
Resolution	16-bit	
Compatibility	TTL level	
Base Clock	10 MHz, 1MHz, 100kHz, 10kHz	
Max. Input Frequency	10 MHz	
Clock Input	Low	0.8 V max.
	High	2.0 V min.
Gate Input	Low	0.8 V max.
	High	2.0 V min.
Counter Output	Low	0.5 V max. @+24 mA
	High	2.4 V min. @-15 mA

General:

I/O Connector Type	68-pin SCSI-II female	
Dimensions	175 mm x 100 mm (6.9" x 3.9")	
Power Consumption	Typical	+5 V @ 850 mA +12 V @ 600 mA
	Max.	+5 V @ 1 A +12 V @ 700m A
Temperature	Operation	0~+60° C (32~140° F) (refer to IEC 68-2-1,2)
	Storage	-20~+85° C (-4~185° F)
Relative Humidity	5~95%RH non-condensing (refer to IEC 68-2-3)	
Certification	CE certified	

Note:

- ✎ The sampling rate depends on the computer hardware architecture and software environment. The rates may vary due to programming language, code efficiency, CPU utilization and so on.

B. Block Diagram

Block Diagram

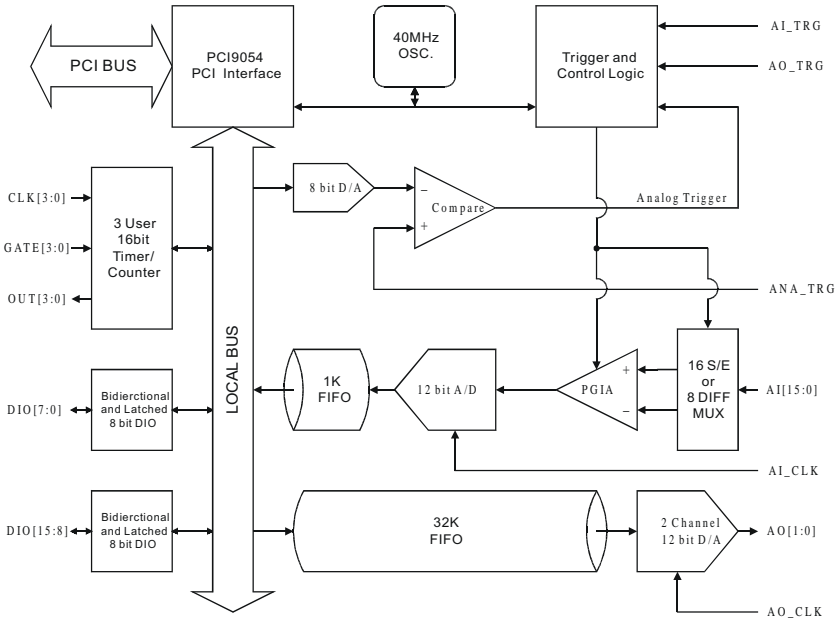

APPENDIX B

C. Screw-terminal Board

C. 1 Introduction

The PCLD-8712 Screw-terminal Board provides convenient and reliable signal wiring for the PCI-1712/1712L of which has a 68-pin SCSI-II connector. Due to its special PCB layout you can install passive components to construct your own signal-conditioning circuits. The user can easily construct a low-pass filter, attenuator or current shunt converter by adding resistors and capacitors on board's circuit pads.

C. 2 Features

- Low-cost screw-terminal board for the PCI-1712/1712L with 68-pin SCSI-II connector.
- Reserved space for signal-conditioning circuits such as low-pass filter, voltage attenuator and current shunt.
- Industrial-grade screw-clamp terminal blocks for heavy-duty and reliable connections.
- DIN-rail mounting case for easy mounting.
- Dimensions: 169 mm (W) x 112mm (L) x 51mm (H) (6.7" x 4.4" x 2.0")

C. 3 Board Layout

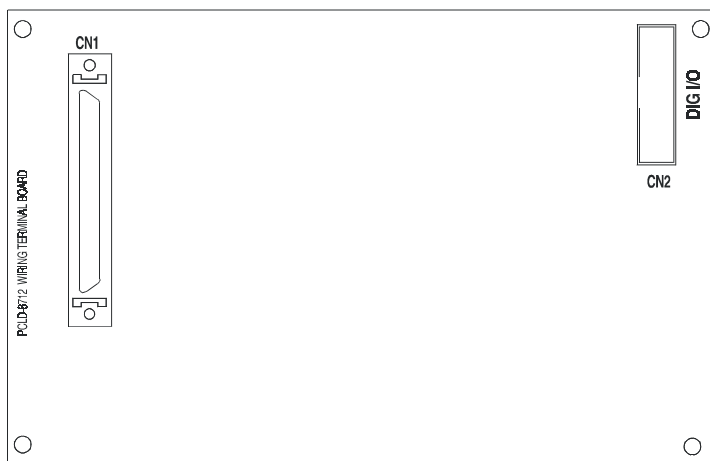

Figure C-1: PCLD-8712 board layout

CN1: 68-pin SCSI-II connector for connection with the PCI-1712

CN2: 20-pin connector for digital I/O

C.4 Pin Assignment

CN2			
DIO 0	1	2	DIO 1
DIO 2	3	4	DIO 3
DIO 4	5	6	DIO 5
DIO 6	7	8	DIO 7
DIO 8	9	10	DIO 9
DIO 10	11	12	DIO 11
DIO 12	13	14	DIO 13
DIO 14	15	16	DIO 15
DGND	17	18	DGND
+5 V	19	20	+12 V

Figure C-2: CN2 pin assignments for the PCLD-8712

C.5 Single-ended Connections

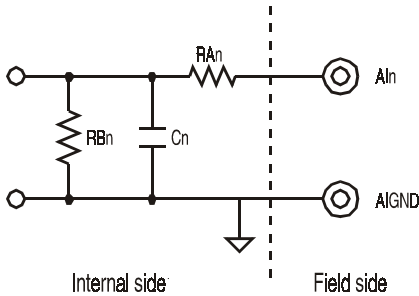

where $n = 0, 1, 2, \dots, 15$

- a) Straight-through connection

(factory setting)

$R_{An} = 0 \Omega$ (short)

$R_{Bn} = \text{none}$

$C_n = \text{none}$

- b) 1.6 kHz (3dB) low pass filter

$R_{An} = 10 \text{ k} \Omega$

$R_{Bn} = \text{none}$

$C_n = 0.01 \mu\text{F}$

$$f_{3\text{dB}} = \frac{1}{2\pi R_{An} C_n}$$

- c) 10 : 1 voltage attenuator:

$R_{An} = 9 \text{ k} \Omega$

$R_{Bn} = 1 \text{ k} \Omega$

$C_n = \text{none}$

$$\text{Attenuation} = \frac{R_{Bn}}{R_{An} + R_{Bn}}$$

- d) 4 ~ 20 mA to 1 ~ 5 V_{DC} signal converter:

$R_{An} = 0 \Omega$ (short)

$R_{Bn} = 250 \Omega$ (0.1% precision resistor)

$C_n = \text{none}$

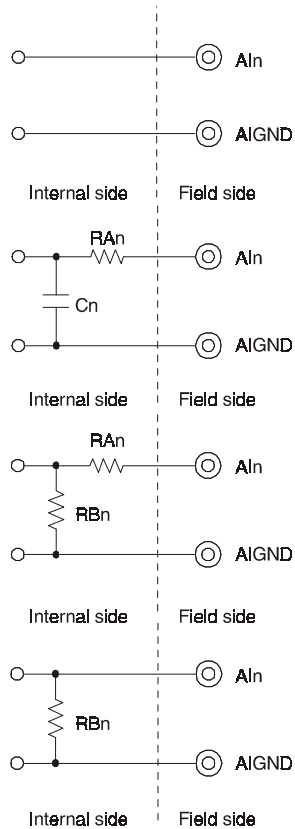

C.6 Differential Connections

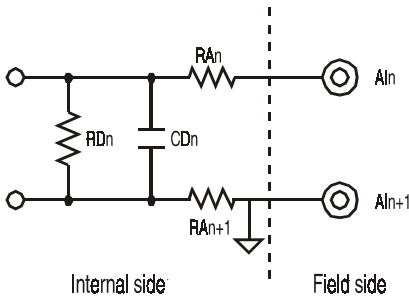

where $n = 0, 2, 4, \dots, 14$

- a) Straight-through connection (factory setting):

$R_{An} = 0 \Omega$ (short)
 $R_{An+1} = 0 \Omega$ (short)
 $R_{Dn} = \text{none}$
 $C_{Dn} = \text{none}$

- b) 1.6 kHz (3dB) low pass filter

$R_{An} = 5 \text{ k}\Omega$
 $R_{An+1} = 5 \text{ k}\Omega$
 $R_{Dn} = \text{none}$
 $C_{Dn} = 0.01 \mu\text{F}$
 $f_{3\text{dB}} = \frac{1}{2\pi (R_{An} + R_{An+1}) C_{Dn}}$

- c) 10 : 1 voltage attenuator:

$R_{An} = 4.5 \text{ k}\Omega$
 $R_{An+1} = 4.5 \text{ k}\Omega$
 $R_{Dn} = 1 \text{ k}\Omega$
 $C_n = \text{none}$
 $\text{Attenuation} = \frac{R_{Dn}}{R_{An} + R_{An+1} + R_{Dn}}$

- d) 4 ~ 20 mA to 1 ~ 5 V_{DC} signal converter:

$R_{An} = 0 \Omega$ (short)
 $R_{An+1} = 0 \Omega$ (short)
 $R_{Dn} = 250 \Omega$ (0.1% precision resistor)
 $C_{Dn} = \text{none}$

3. Calculations

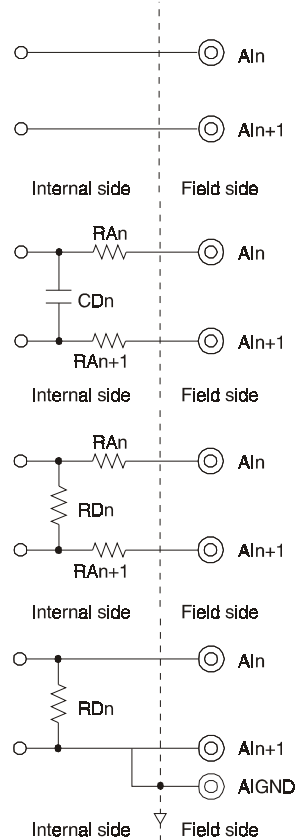

D. Register Structure and Format

D.1 Overview

The PCI-1712/1712L is delivered with an easy-to-use 32-bit DLL driver for user programming under Windows 95/98/NT operating system. We advise users to program the PCI-1712/1712L using 32-bit DLL driver provided by Advantech to avoid the complexity of low-level programming by register.

The most important consideration in programming the PCI-1712/1712L at the register level is to understand the function of the card's registers. The information in the following sections is provided for users who would like to do their own register-level programming.

D.2 I/O Port Address Map

The PCI-1712/1712L requires 50 consecutive addresses in the PC's I/O space. The address of each register is specified as an offset from the card's base address. For example, BASE+0 is the card's base address and BASE+8 is the base address plus eight bytes. The following sections give the detailed information about register layout, and also the detailed information about each register or driver and its address relative to the card's base address.

Table D-1 shows the function of each register or driver and its address relative to the card's base address.

Note

- ✎ All base address is in hexadecimal in Appendix D.
 - ✎ Users have to use a 16-bit (word) I/O command to read/write each register.
-

Table D-1: PCI-1712/1712L register format (Part 1)

Base Address		PCI-1712/1712L Register Format															
		15	14	13	12	11	10	9	8	7	6	5	4	3	2	1	0
0	W	A/D single value acquisition															
	R	Channel and A/D data															
		AF	CH2	CH1	CH0	AD11	AD10	AD9	AD8	AD7	AD6	AD5	AD4	AD3	AD2	AD1	AD0
2	W	A/D channel range setting															
	R	N/A															
4	W	Multiplexer setting															
	R	N/A															
6	W	A/D control register															
	R	A/D status register															
		AI_TRGF	DMA_TCF							AIO_CAL	AD_TRE		AD_TR	AD_CLK	ADM2	ADM1	ADM0
8	W	Clear interrupt and FIFO															
	R	Interrupt and FIFO status															
		CLR_DAF				CLR_ADF											INT_F
A	W	D/A control register															
	R	D/A status register															
		AO_TRGF				DA_CLK		DAM1	DAM0		DA1_U/B	DA1_I/E	DA1_5/10		DA_U/B	DA0_I/E	DA0_5/10
C	W	D/A channel 0 data															
	R	N/A															
						DA11	DA10	DA9	DA8	DA7	DA6	DA5	DA4	DA3	DA2	DA1	DA0
E	W	D/A channel 1 data															
	R	N/A															
						DA11	DA10	DA9	DA8	DA7	DA6	DA5	DA4	DA3	DA2	DA1	DA0

Table D-1: PCI-1712/1712L register format (Part 2)

Base Address		PCI-1712/1712L Register Format															
		15	14	13	12	11	10	9	8	7	6	5	4	3	2	1	0
10	W	D/A counter 0															
										D7	D6	D5	D4	D3	D2	D1	D0
10	R	D/A counter 0															
										D7	D6	D5	D4	D3	D2	D1	D0
12	W	A/D counter 1															
										D7	D6	D5	D4	D3	D2	D1	D0
12	R	A/D counter 1															
										D7	D6	D5	D4	D3	D2	D1	D0
14	W	DMA counter 2															
										D7	D6	D5	D4	D3	D2	D1	D0
14	R	DMA counter 2															
										D7	D6	D5	D4	D3	D2	D1	D0
16	W	Counter control															
										D7	D6	D5	D4	D3	D2	D1	D0
16	R	Counter control															
										D7	D6	D5	D4	D3	D2	D1	D0
18	W	Counter 0															
										D7	D6	D5	D4	D3	D2	D1	D0
18	R	Counter 0															
										D7	D6	D5	D4	D3	D2	D1	D0
1A	W	Counter 1															
										D7	D6	D5	D4	D3	D2	D1	D0
1A	R	Counter 1															
										D7	D6	D5	D4	D3	D2	D1	D0
1C	W	Counter 2															
										D7	D6	D5	D4	D3	D2	D1	D0
1C	R	Counter 2															
										D7	D6	D5	D4	D3	D2	D1	D0
1E	W	Counter control															
										D7	D6	D5	D4	D3	D2	D1	D0
1E	R	Counter control															
										D7	D6	D5	D4	D3	D2	D1	D0

Table D-1: PCI-1712/1712L register format (Part 3)

Base Address		PCI-1712/1712L Register Format															
		15	14	13	12	11	10	9	8	7	6	5	4	3	2	1	0
20	W	Counter 0 gate and clock control															
									GR0	GQ0	GP0	G01	G00	CQ0	CP0	C01	C00
20	R	Counter 0 gate and clock status															
							GATE-S0	CLK0	OUT0	GAT-E0	GQ0	GP0	G01	G00	CQ0	CP0	C01
22	W	Counter 1 gate and clock control															
									GR1	GQ1	GP1	G11	G10	CQ1	CP1	C11	C10
22	R	Counter 1 gate and clock status															
							GAT-ES1	CLK1	OUT1	GAT-E1	GQ1	GP1	G11	G10	CQ1	CP1	C11
24	W	Counter 2 gate and clock control															
									GR2	GQ2	GP2	G21	G20	CQ2	CP2	C21	C20
24	R	Counter 2 gate and clock status															
							GAT-ES2	CLK2	OUT2	GAT-E2	GQ2	GP2	G21	G20	CQ2	CP2	C21
26	W	Counter internal clock source select register															
																	CLK-SEL1
26	R	N/A															
28	W	Digital Output															
		DO15	DO14	DO13	DO12	DO11	DO10	DO9	DO8	DO7	DO6	DO5	DO4	DO3	DO2	DO1	DO0
28	R	Digital Input															
		DI15	DI14	DI13	DI12	DI11	DI10	DI9	DI8	DI7	DI6	DI5	DI4	DI3	DI2	DI1	DI0
2A	W	Digital I/O configuration register															
																	DIO-C1
2A	R	Digital I/O configuration register															
																	DIO-C1
2C	W	Calibration command and data															
							CM3	CM2	CM1	CM0	D7	D6	D5	D4	D3	D2	D1
2C	R	N/A															
2E	W	N/A															
2E	R	N/A															
30	W	D/A channel data for continuous output operation mode															
							DA11	DA10	DA9	DA8	DA7	DA6	DA5	DA4	DA3	DA2	DA1

D.3 A/D Single Value Acquisition — Write BASE+0

The A/D converter will convert one sample when you write to the register **Write BASE+0** with any value. User can check the A/D FIFO status (**A/D_F/E on register Read BASE+8**) to make sure if the data is ready to be received.

D.4 Channel and A/D data — Read BASE + 0

These two bytes in **Read BASE+0** hold the result of A/D conversion data.

The 12 bits of data from the A/D conversion are stored in bit 0 to bit 11, bit 12 to 14 hold the A/D channel number and bit 15 holds the trigger event flag.

Table D-2: Register for channel number and A/D data

Base Add.	15	14	13	12	11	10	9	8	7	6	5	4	3	2	1	0
0	R	Channel and A/D data														
		AF	CH2	CH1	CH0	AD11	AD10	AD9	AD8	AD7	AD6	AD5	AD4	AD3	AD2	AD1

AD11 TO AD0 Data of A/D Conversion

AD0 the least significant bit (LSB) of A/D data.
 AD11 the most significant bit (MSB) of A/D data.

CH2 to CH0 A/D Channel Number

CH2 ~ CH0 hold the A/D channel number from which the data is received.
 CH2 MSB.
 CH0 LSB.

Note:

- ✎ A/D channel number specifies the channel from which data is derived. CH2 is the MSB and CH0 is the LSB. For channel scan, there should have 4 channel codes, specifically from CH0 to CH3. Because we have not enough address space, bit 15 is used for other purposes instead for CH3, which is hence not available..

AF A/D trigger event flag

The trigger flag indicates whether a trigger event has happened during A/D conversion process.

0 means the data on AD11 to AD0 is stored before trigger.

1 means the data on AD11 to AD0 is stored after trigger.

The trigger event flag plays an important role in post-, delay-, about- and pre-trigger acquisition modes. For detailed information, please refer to Chapter 5.1 Analog Input Features.

D.5 A/D Channel Range Setting — Write BASE+2

Each A/D channel has its own input range, controlled by a gain code stored in on-board RAM.

To change the A/D channel input range for a channel:

- ◆ Write the same channel in **Write BASE+4** bit 0 to bit 3 (the start channel) and bit 8 to bit 11 (the stop channel).
- ◆ Write the gain code to **Write BASE+2** bit 0 to bit2.
- ◆ Write 0 or 1 to **Write BASE+2** bit 4 to set unipolar or bipolar input.

Table D-3: Register for A/D channel range setting

Base Add.	15	14	13	12	11	10	9	8	7	6	5	4	3	2	1	0
2	W	A/D channel range setting														
													S/D	B/U		G2

S/D Single-ended or Differential

0 means the channel is single-ended input.

1 means the channel is differential input.

B/U Bipolar or Unipolar

0 means the channel is bipolar.

1 means the channel is unipolar.

G2 to G0 Gain Code

Table D-4: Gain Codes for the PCI-1712/1712L

B/U	Gain Code			Gain	Input Range (V)
	G2	G1	G0		
0	0	0	0	1	-5 ~ +5
0	0	0	1	2	-2.5 ~ +2.5
0	0	1	0	4	-1.25 ~ +1.25
0	0	1	1	8	-0.625 ~ +0.625
0	1	0	0	0.5	-10 ~ +10
1	0	0	0	1	0 ~ 10
1	0	0	1	2	0 ~ 5
1	0	1	0	4	0 ~ 2.5
1	0	1	1	8	0 ~ 1.25

D.6 MUX Control — Write BASE+4

Table D-5: Register for multiplexer control

Base Add.	15	14	13	12	11	10	9	8	7	6	5	4	3	2	1	0
4	W	Multiplexer setting														
						STP3	STP2	STP1	STP0						STR3	STR2

STR3 ~ STR0 **Start Scan Channel Number**

STP3 ~ STP0 **Stop Scan Channel Number**

When you set the gain code of analog input channel n, you should set the MUX start & stop channel number to channel n to prevent any unexpected errors. In fact, Write BASE+4 bit 3 to 0, STR3 ~ STR0, act as a pointer to the address of channel n in the SRAM when you program the A/D channel setting (refer to Section D.5).

Note:

- ✎ We recommend that you set the same start and stop channel when writing to the register **Write BASE+2**. Otherwise, if the A/D trigger source is on, the multiplexer will continuously scan between channels and the range settings may be set to an unexpected channel. Make sure the A/D trigger source is turned off to avoid this kind of error.

The write-only register of Write BASE+4 controls how the multiplexers (MUXs) scan.

- ◆ Write BASE+4 bit 3 to bit 0, STR3 ~ STR0, hold the start scan channel number.
- ◆ Write BASE+4 bit 11 to bit 8, STP3 ~ STP0, hold the stop scan channel number.

Writing to the register automatically initializes the MUXs to the start and stop channel. Each A/D conversion trigger also sets MUXs to the next channel. With continuous triggering, the MUXs will scan from the start channel to the stop channel and then repeat. The following examples show the scan sequences of the MUXs (all channels are set as single-ended).

Example 1

If the start scan input channel is AI3 and the stop scan input channel is AI7, then the scan sequence is AI3, AI 4, AI 5, AI6, AI7, AI3, AI4, AI5, AI6, AI7, AI3, AI4...

Example 2

If the start scan input channel is AI13 and the stop scan input channel is AI2, then the scan sequence is AI13, AI14, AI15, AI0, AI1, AI2, AI13, AI14, AI15, AI0, AI1, AI2, AI13, AI14...

The scan logic of PCI-1712/1712L card is pretty fancy and powerful, you can set gain code, B/U and S/D by each channel. The scan logic will be a little complex if you set the channel in differential mode. In differential mode, the even channel (i.e. AI0, AI2, AI4...AI14) and odd channel (i.e. AI1, AI3, AI5...AI15) are combined to one channel. The odd channel is the positive end and the even one is negative end. For example, if the AI0 is set as differential mode, then the AI0 and AI1 are combined to one channel and refer to the gain code and B/U of AI0 (the AI1's is useless). As the same rule, if the AI2 is set as differential mode, then the AI2 and AI3 are combined to one channel and refer to the gain code and B/U of AI2 (the AI3's is useless). The following examples show the scan sequence of differential mode.

Example 3

Suppose that the start scan input channel is AI2 and the stop scan input channel is AI8. If AI2 is differential mode (D), AI4 is D, AI6 is D and AI7 and AI8 are single-ended mode (S), then the scan sequence is AI2, AI4, AI6, AI7, AI8, AI2, AI4, AI6, AI7, AI8, AI2, AI4...

Example 4

Suppose that the start scan input channel is AI14 and the stop scan input channel is AI3. If AI14 is D, AI0 and AI1 are S, AI2 is D, then the scan sequence is AI14, AI0, AI1, AI2, AI14, AI0, AI1, AI2, AI14, AI0, AI1...

Example 5

Suppose that the start scan input channel is AI11 and the stop scan input channel is AI15. If AI11 is S, AI12 is D, AI14 is D, then the scan sequence is AI11, AI12, AI14, AI11, AI12, AI14, AI11, AI12...

Example 6

Suppose that the start scan input channel is AI4 and the stop scan input channel is AI7. If AI4 is S, AI5 is D, AI6 is D, then the scan sequence is AI4, AI5, AI7, AI4, AI5, AI7, AI4, AI5...

Note

- ⚠ This is an error setting of channel scan sequence, user have to avoid setting even channel as S and odd channel as D.

D.7 A/D Control/Status Register — Write/Read BASE+6

Table D-6: Register for A/D control/status

Base Add.	15	14	13	12	11	10	9	8	7	6	5	4	3	2	1	0
6	W	A/D control register														
		AI_T RGF	DM A_T CF								AIO_ CAL	AD_ TRE		AD_ TR	AD_ CLK	ADM2
6	R	A/D status register														
		AI_T RGF	DMA _TCF								AD_ TRE		AD_ TR	AD_ CLK	ADM2	ADM1

ADM2 ~ ADM0**Analog input acquisition mode register**

These registers specify the analog input acquisition mode.

The following table shows the acquisition mode.

Table D-7: Analog Input Acquisition Mode

ADM2	ADM1	ADM0	Meaning
0	0	0	Single Value Acquisition Mode
0	0	1	Pacer Acquisition Mode
0	1	0	Post-Trigger Acquisition Mode
0	1	1	Delay-Trigger Acquisition Mode
1	0	0	About-Trigger Acquisition Mode

AD_CLK A/D sample clock source select register

This bit is used to select the A/D sample clock source.

0 means internal clock.

1 means external clock (from pin AI_CLK).

AD_TR Trigger source control register

This bit is used to select the A/D conversion trigger source.

0 means external digital TTL-trigger (from pin AI_TRG).

1 means threshold analog trigger (from pin ANA_TRG).

AD_TRE Trigger edge control register

This bit specifies the type of trigger edge for A/D conversion.

0 means rising edge.

1 means falling edge.

AIO_CAL Analog I/O calibration bit

This bit sets the Analog I/O calibration mode.

0 means the PCI-1712 is in normal mode. All analog input channels are connected to 68 pin SCSI-II connector respectively.

1 means the PCI-1712 is in AI/O calibration mode. The wiring becomes that AI0 is connected to 0 V (AGND), AI2 is connected to +5 V, AI4 is connected to AO0, and AI6 is connected to AO1 automatically.

DMA_TCF DMA terminal count flag

This bit indicates if the DMA counter is terminal count.

1 means terminal count of DMA counter occurred.

You can write 1 to DMA_TCF, then it acts as if terminal count occurred. This function is useful for user to test and debug the application. Before initiating a delay-, about- or pre-trigger acquisition mode, you have to write 0 to clear this bit first.

AI_TRGF Analog input trigger flag

This bit indicates whether the A/D trigger event occurred. 1 means A/D trigger event has occurred.

You can write 1 to AI_TRGF, then it acts as if A/D trigger event has occurred. It is useful for you to test and debug the application. Before initiating a post-, delay-, about- or pre-trigger acquisition mode, you have to write 0 to clear this bit first.

D.8 Clear interrupt and FIFO — Write BASE+8

Table D-8: Register for clear interrupt and FIFO

Base Add.	15	14	13	12	11	10	9	8	7	6	5	4	3	2	1	0
8	W	Clear interrupt and FIFO														
		CLR_DAF				CLR_ADF										

Clear interrupt Write any values to **Write BASE+8** low byte clears the interrupt.

CLR_ADF Clear A/D FIFO

Write 0 to this bit will clear the A/D FIFO.

CLR_DAF Clear D/A FIFO

Write 0 to this bit will clear the D/A FIFO.

D. 9 Interrupt and FIFO status — Read BASE+8

Table D-9: Register for interrupt and FIFO status

Base Addr.		15	14	13	12	11	10	9	8	7	6	5	4	3	2	1	0
8	R	Interrupt and FIFO status															
		D/A_F/F	D/A_F/H	D/A_F/E		A/D_F/F	A/D_F/H	A/D_F/E									

INT_F Interrupt flag
 This bit indicates whether interrupt occurred or not.
 1 means that an interrupt has occurred.

A/D_F/E A/D FIFO empty flag
 This bit indicates the A/D FIFO empty status
 1 means A/D FIFO empty.

A/D_F/H A/D FIFO half-full flag
 This bit indicates the A/D FIFO half-full status
 1 means A/D FIFO half-full.

A/D_F/F A/D FIFO full flag
 This bit indicates the A/D FIFO full status
 1 means A/D FIFO full.

D/A_F/E D/A FIFO empty flag
 This bit indicates the D/A FIFO empty status
 1 means D/A FIFO empty.

D/A_F/H D/A FIFO half-full flag
 This bit indicates the D/A FIFO half-full status
 1 means D/A FIFO half-full.

D/A_F/F D/A FIFO full flag
 This bit indicates the D/A FIFO full status
 1 means D/A FIFO full.

D.10 D/A control/status register — Write/Read BASE+A

Table D-10: Register for D/A control

Base Add.		15	14	13	12	11	10	9	8	7	6	5	4	3	2	1	0
A	W	D/A control register															
		AO_TRGF				DA_CLK		DAMI	DAM0		DA1_U/B	DA1_I/E	DA1_5/10		DA_U/B	DA0_I/E	DA0_5/10
	R	D/A status register															
		AO_TRGF				DA_CLK		DAMI	DAM0		DA1_U/B	DA1_I/E	DA1_5/10		DA_U/B	DA0_I/E	DA0_5/10

DA0_5/10 D/A channel 0 internal reference voltage

This bit specifies the internal reference voltage of AO0.

0 means the internal reference voltage is 5V

1 means the internal reference voltage is 10V.

DA0_I/E D/A channel 0 internal or external reference

This bit specifies the reference voltage of AO0 as internal or external.

0 means the reference voltage comes from internal.

1 means the reference voltage comes from pin AO0_REF.

DA0_U/B D/A channel 0 unipolar or bipolar output

This bit specifies the output voltage of AO0 as unipolar or bipolar.

0 means the output voltage is unipolar

1 means the output voltage is bipolar.

DA1_5/10 D/A channel 1 internal reference voltage

This bit specifies the internal reference voltage of AO1.

0 means the internal reference voltage is 5V.

1 means the internal reference voltage is 10V.

DA1_I/E D/A channel 1 internal or external reference

This bit specifies the reference voltage of AO1 as internal or external.

0 means the reference voltage comes from internal.

1 means the reference voltage comes from pin AO1_REF.

DA1_U/B D/A channel 1 unipolar or bipolar output

This bit specifies the output voltage of AO1 as unipolar or bipolar.

0 means the output voltage is unipolar.

1 means the output voltage is bipolar.

DAM1 to DAM0 Analog output operation mode register

These two bits control the analog output operation mode.

Table D-11: Analog output operation mode

DAM1	DAM0	Meaning	
		D/A CH1	D/A CH0
0	0	Single Value Operation Mode	Single Value Operation Mode
0	1	Single Value Operation Mode	Continuous Output Operation Mode
1	0	Continuous Output Operation Mode	Single Value Operation Mode
1	1	Continuous Output Operation Mode	Continuous Output Operation Mode

DA_CLK D/A clock source select register

This bit selects the D/A output pacer clock source.

0 means the internal clock.

1 means the external clock from pin AO_CLK. It is used only in continuous output operation mode.

AO_TRGF Analog output trigger flag

This bit indicates the D/A trigger event.

1 means D/A trigger event occurred from pin AO_TRG.

If you write 1 to AO_TRGF, then it acts as if D/A trigger event has occurred. This is useful for testing and debugging. This function is applicable only in continuously output operation mode.

D.11 D/A Channel 0/1 Data — Write BASE+C/E

Table D-12: Register for D/A channel 0/1 data

Base Add.		15	14	13	12	11	10	9	8	7	6	5	4	3	2	1	0
C	W	D/A channel 0 data															
						DA11	DA10	DA9	DA8	DA7	DA6	DA5	DA4	DA3	DA2	DA1	DA0
E	W	D/A channel 1 data															
						DA11	DA10	DA9	DA8	DA7	DA6	DA5	DA4	DA3	DA2	DA1	DA0

DA11 TO DA0 D/A data

DA0 is the least significant bit (LSB) of the D/A data

DA11 is the most significant bit (MSB).

Note:

- These two base addresses are used for single value operation mode only. For continuous output operation mode, data have to be written to BASE+30.

Base Add.		15	14	13	12	11	10	9	8	7	6	5	4	3	2	1	0
30	W	D/A channel data for continuous output operation mode															
						DA11	DA10	DA9	DA8	DA7	DA6	DA5	DA4	DA3	DA2	DA1	DA0

D.12 82C54 Counter Chip 0 — Write/Read BASE+10 to 16

Table D-13: Register for 82C54 counter chip 0

Base Add.		15	14	13	12	11	10	9	8	7	6	5	4	3	2	1	0	
10	W	D/A counter 0																
											D7	D6	D5	D4	D3	D2	D1	D0
	R	D/A counter 0																
												D7	D6	D5	D4	D3	D2	D1
12	W	A/D counter 1																
												D7	D6	D5	D4	D3	D2	D1
	R	A/D counter 1																
												D7	D6	D5	D4	D3	D2	D1
14	W	DMA counter 2																
												D7	D6	D5	D4	D3	D2	D1
	R	DMA counter 2																
												D7	D6	D5	D4	D3	D2	D1
16	W	Counter control																
												D7	D6	D5	D4	D3	D2	D1
	R	Counter control																
												D7	D6	D5	D4	D3	D2	D1

This counter chip 82C54 includes three counters use for special purpose. Counter 0 is used as D/A counter to produce D/A output pacer clock. Counter 1 is used as A/D counter to produce A/D pacer clock. Counter 2 is used as DMA counter. Counter 0 and counter 1 should set in 82C54 mode 3 or mode 2 to produce clock. Counter 1 set in mode 0 to count number of data. For detailed information, Intel(r) 82C54 User’s Manual is available by accessing the following path on CD-ROM:

\Document\Intel 82C54 manual.pdf

D.13 82C54 counter chip 1 — Write/Read BASE+18 to 1E

Table D-14: Register for 82C54 counter chip 1

Base Add.		15	14	13	12	11	10	9	8	7	6	5	4	3	2	1	0	
18	W	D/A counter 0																
											D7	D6	D5	D4	D3	D2	D1	D0
	R	D/A counter 0																
												D7	D6	D5	D4	D3	D2	D1
1A	W	A/D counter 1																
												D7	D6	D5	D4	D3	D2	D1
	R	A/D counter 1																
												D7	D6	D5	D4	D3	D2	D1
1C	W	DMA counter 2																
												D7	D6	D5	D4	D3	D2	D1
	R	DMA counter 2																
												D7	D6	D5	D4	D3	D2	D1
1E	W	Counter control																
												D7	D6	D5	D4	D3	D2	D1
	R	Counter control																
												D7	D6	D5	D4	D3	D2	D1

This counter chip 82C54 includes three counters for general purpose. These three counters are identical. They can do event counting, rate generation, one shot, frequency measurement and pulse width measurement. Please refer to chapter 5.3 for more details about the principles of operation. In order to explain the functions of three counters clearly, we adopt a naming rule to designate the counter number. For example, as you will see in the subsequent sections, there are many registers with names like Cn0, CPn, CQn, etc. Note that the “n” in these register names represents the counter number that is concerned.

D.14 Counter gate and clock control/status — Write/Read BASE+20 to 26

Table D-15: Register for counter gate and clock control/status

Base Add.	15	14	13	12	11	10	9	8	7	6	5	4	3	2	1	0	
20	W	Counter 0 gate and clock control															
								GR0	GQ0	GP0	G01	G00	CQ0	CP0	C01	C00	
20	R	Counter 0 gate and clock status															
						GAT-ES0	CLK0	OUT0	GAT-E0	GQ0	GP0	G01	G00	CQ0	CP0	C01	C00
22	W	Counter 1 gate and clock control															
								GR1	GQ1	GP1	G11	G10	CQ1	CP1	C11	C10	
22	R	Counter 1 gate and clock status															
						GAT-ES1	CLK1	OUT1	GAT-E1	GQ1	GP1	G11	G10	CQ1	CP1	C11	C10
24	W	Counter 2 gate and clock control															
								GR2	GQ2	GP2	G21	G20	CQ2	CP2	C21	C20	
24	R	Counter 2 gate and clock status															
						GAT-ES2	CLK2	OUT2	GAT-E2	GQ2	GP2	G21	G20	CQ2	CP2	C21	C20
26	W	Counter internal clock source select register															
																CLK_SEL1	CLK_SEL0
26	R	N/A															

Cn1 to Cn0 Counter clock source control register n = 0,1,2

Table D-16 : Table of Cn1 to Cn0 register

Cn1	Cn0	Meaning
0	0	Clock is set by CQn
0	1	Clock comes from internal clock
1	0	Clock comes from external clock
1	1	Clock comes from previous counter's out

[Cn1 : Cn0] = [0, 0], write CQn to set the counter clock. Refer to CQn description.

[Cn1 : Cn0] = [0, 1], The internal clock is generated by an on-board oscillator.

[Cn1 : Cn0] = [1, 0], External clock is on connector CNTn_CLK (n = 0, 1, 2).

[Cn1 : Cn0] = [1, 1], The clock source of every counter

comes from its previous counter's output in a round-robin fashion. For example, the source of counter 0 comes from the output of its previous counter, i.e. counter 2, whose source in turn comes from counter 1, whose source comes from counter 0, etc.

CPn Counter clock edge control register n = 0,1,2

This bit specifies whether the clock will act as a rising or falling trigger.

0 means rising edge.

1 means falling edge.

CQn Counter clock set register n = 0,1,2

When $[Cn1 : Cn0] = [0, 0]$, which means the clock input of counter n is set by CQn through software, a pulse will be generated when bit CQn being written to. For example, if a "1" is written to CQn with an original value of "0", then a rising-edge pulse will be generated, which will serve as the clock input of counter n. If a "0" is written to CQn with an original value of "1", then a falling-edge pulse will be generated.

This function is necessary for users who want to load the register data to the 82C54 chip.

Gn1 to Gn0 Counter gate source control register n = 0,1,2

Table D-17: Table of Gn1 to Gn0 register

Gn1	Gn0	Meaning
0	0	Gate is set by GQn
0	1	Gate comes from previous counter's output
1	0	Gate comes from external gate
1	1	Gate use for pulse width measurement

$[Gn1 : Gn0] = [0, 0]$, write GQn to set the counter gate. Refer to CQn description.

$[Gn1 : Gn0] = [0, 1]$, The gate source comes from the previous counter's output. The previous counter of counter 0 is counter 2, of counter 1 is counter 0 and of counter 2 is counter 1. The gate source of every counter comes from its previous counter's output in a round-robin fashion. For example, the gate source of counter 0 comes from the

output of its previous counter, i.e. counter 2, whose gate source in turn comes from counter 1, whose gate source comes from counter 0, etc.

[Gn1: Gn0] = [1, 0], External gate is on connector CNTn_GATE (n = 0, 1, 2).

[Gn1: Gn0] = [1, 1], this mode is for pulse width measurement only.

GPn Counter gate polarity control register n = 0,1,2

This bit specifies whether the gate polarity is positive or negative. “0” means the gate polarity is positive; “1” means the gate polarity is negative.

GQn Counter gate set register n = 0,1,2

When [Gn1: Gn0] = [0, 0], which means the counter gate is set by GQn through software.

For example, you can write 0 to GQN to set gate input of counter n as logic low or write 1 to set it as logic high.

GRn Pulse width measurement reset register n = 0,1,2

Pulse width measurement state machine just allows one positive cycle to pass. Please use rising-edge signal to reset the pulse width measurement state machine before the measured signal input.

GATEn GATE status n = 0,1,2

This bit is read-only and shows the counter’s GATE status. “1” means the gate input of counter n is logic-high; “0” means the gate input of counter n is logic low.

OUTn OUT status n = 0,1,2

This bit is read-only and shows the counter’s OUT status. “1” means the OUT of counter n is logic-high; “0” means logic low.

CLKn CLK status n = 0,1,2

This bit is read-only and shows the counter’s CLK status. “1” means the CLK of counter n is logic-high; “0” means logic low.

GATESn Pulse width measurement status bit n = 0,1,2

This bit is read only which indicates the status of the pulse width measurement state machine. “1” means the measurement is in process; “0” means the measurement is complete.

CLK_SEL1 & 0 Counter internal clock select register

This clock is for counter 0 to 2 internal clock source.

The register sets the frequency of internal clock source of counter 0 to counter 2.

Table D-18: Table for CLK_SEL1 to CLK_SEL0 register

CLK_SEL1	CLK_SEL0	Meaning
0	0	Internal clock is 10MHz
0	1	Internal clock is 1MHz
1	0	Internal clock is 100KHz
1	1	Internal clock is 10KHz

D.15 Digital I/O registers — Write/Read BASE+28

Table D-19: Register for Digital I/O

Base Add.	15	14	13	12	11	10	9	8	7	6	5	4	3	2	1	0
28	W	Digital Output														
		DO15	DO14	DO13	DO12	DO11	DO10	DO9	DO8	DO7	DO6	DO5	DO4	DO3	DO2	DO1
	R	Digital Input														
		DO15	DO14	DO13	DO12	DO11	DO10	DO9	DO8	DO7	DO6	DO5	DO4	DO3	DO2	DO1

The PCI-1712/1712L provides 16 digital I/O channels. Each group of 8 channels can be defined as both input or output channels. You can configure digital input/output by setting the digital I/O configuration register. Refer to next section for more details.

DO15 to DO0 Digital output data register

DO0 is the least significant bit (LSB) of the digital output data.

DO15 is the most significant bit (MSB) of the digital output data.

D15 to DIO Digital input data register

DIO is the least significant bit (LSB) of the digital input data.
 D15 is the most significant bit (MSB) of the digital input data.

D.16 Digital I/O configuration registers — Write/Read BASE+2A

Table D-20: Register for digital I/O configuration

Base Add.		15	14	13	12	11	10	9	8	7	6	5	4	3	2	1	0
2A	W	Digital I/O configuration register															
														DIO_C1			
	R	Digital I/O configuration register															
															DIO_C1		

DIO_C1 to DIO_C0 Digital I/O configuration register

Table D-21: Register for digital I/O configuration

DIO_C1	DIO_C0	Meaning	
		High Byte (bit 15 to 8)	Low Byte (bit 7 to 0)
0	0	Output	Output
0	1	Output	Input
1	0	Input	Output
1	1	Input	Input

When all digital I/O channels are set as output channels, users can confirm the data output status by reading back from digital input data registers.

D.17 Calibration command registers — Write BASE+2C

Table D-22: Register for calibration command

Base Add.		15	14	13	12	11	10	9	8	7	6	5	4	3	2	1	0
2C	W	Calibration command and data															
						CM3	CM2	CM1	CM0	D7	D6	D5	D4	D3	D2	D1	D0

D7 to D0 Calibration data

D0 is the least significant bit (LSB) of the calibration data.

D7 is the most significant bit (MSB) of the calibration data.

CM3 to CM0 Calibration command

Table D-23: Calibration command

CM3	CM2	CM1	CM0	Meaning
0	0	0	0	A/D bipolar offset adjustment
0	0	0	1	A/D unipolar offset adjustment
0	0	1	0	PGA offset adjustment
0	0	1	1	A/D gain adjustment
0	1	0	0	D/A channel 0 gain adjustment
0	1	0	1	D/A channel 0 bipolar offset adjustment
0	1	1	0	D/A channel 0 unipolar offset adjustment
0	1	1	1	D/A channel 1 gain adjustment
1	0	0	0	D/A channel 1 bipolar offset adjustment
1	0	0	1	D/A channel 1 unipolar offset adjustment
1	0	1	0	Analog threshold voltage adjustment
1	0	1	1	N/A
1	1	0	0	N/A
1	1	0	1	N/A
1	1	1	0	N/A
1	1	1	1	N/A

D.18 D/A Channel Data for Continuous Output Operation Mode — Write BASE+30

Table D-24: Register for D/A channel data

Base Add.	15	14	13	12	11	10	9	8	7	6	5	4	3	2	1	0
30	W	D/A channel data for continuous output operation mode														
						DA11	DA10	DA9	DA8	DA7	DA6	DA5	DA4	DA3	DA2	DA1

DA11 TO DA0 D/A data

DA0 is the least significant bit (LSB) of the D/A data

DA11 is the most significant bit (MSB).

Note

- ⚠ This base address is used for continuous output operation mode only. If the two D/A channels are both operating in continuous output mode, the data in FIFO will be sent in an interlaced manner, i.e. The “even” samples in the FIFO are sent to D/A channel 0, while the “odd” samples to D/A channel 1.
-