

ADAM-4570/ADAM-4571/EDG-4504

**1/2/4 Port Ethernet to
RS-232/422/485 Data Gateway
User's Manual**

Copyright Notice

This document is copyrighted, 2001, by Advantech Co., Ltd. All rights are reserved. Advantech Co., Ltd., reserves the right to make improvements to the products described in this manual at any time without notice.

No part of this manual may be reproduced, copied, translated or transmitted in any form or by any means without the prior written permission of Advantech Co., Ltd. Information provided in this manual is intended to be accurate and reliable. However, Advantech Co., Ltd. assumes no responsibility for its use, nor for any infringements upon the rights of third parties which may result from its use.

CE Notification

The ADAM-4570/ADAM-4571/EDG-4504 has passed the CE test for environmental specifications. Test conditions for passing included the equipment being operated within an industrial enclosure. In order to protect the ADAM-4570/ADAM-4571/EDG-4504 system from being damaged by ESD (Electrostatic Discharge) and EMI leakage, we strongly recommend the use of CE-compliant industrial enclosure products.

Part No. 2000457010 2nd Edition
Printed Taiwan April 2001

Advantech Customer Services

Each and every Advantech product is built to the most exacting specifications to ensure reliable performance in the unusual and demanding conditions typical of industrial environments. Whether your new Advantech equipment is destined for the laboratory or the factory floor, you can be assured that your product will provide the reliability and ease of operation for which the name Advantech has come to be known.

Your satisfaction is our number one concern. Here is a guide to Advantech's customer services. To ensure you get the full benefit of our services, please follow the instructions below carefully.

Technical Support

We want you to get the maximum performance from your products. So if you run into technical difficulties, we are here to help. For most frequently asked questions you can easily find answers in your product documentation. These answers are normally a lot more detailed than the ones we can give over the phone.

Please consult this manual first. If you still cannot find the answer, gather all the information or questions that apply to your problem and, with the product close at hand, call your dealer. Our dealers are well trained and ready to give you the support you need to get the most from your Advantech products. In fact, most problems reported are minor and are able to be easily solved over the phone.

In addition, free technical support is available from Advantech engineers every business day. We are always ready to give advice on application requirements or specific information on the installation and operation of any of our products.

Product Warranty

Advantech warrants to you, the original purchaser, that each of its products will be free from defects in materials and workmanship for two years from the date of purchase.

This warranty does not apply to any products which have been repaired or altered by other than repair personnel authorized by Advantech, or which have been subject to misuse, abuse, accident or improper installation. Advantech assumes no liability as a consequence of such events under the terms of this Warranty.

Because of Advantech's high quality-control standards and rigorous testing, most of our customers never need to use our repair service. If an Advantech product ever does prove defective, it will be repaired or replaced at no charge during the warranty period. For out-of-warranty repairs, you will be billed according to the cost of replacement materials, service time and freight. Please consult your dealer for more details.

If you think you have a defective product, follow these steps:

1. Collect all the information about the problem encountered (e.g. type of PC, CPU speed, Advantech products used, other hardware and software used etc.). Note anything abnormal and list any on-screen messages you get when the problem occurs.
2. Call your dealer and describe the problem. Please have your manual, product, and any helpful information readily available.
3. If your product is diagnosed as defective, you have to request an RMA number. When requesting an RMA (Return Material Authorization) number, please access ADVANTECH's RMA website: <http://www.advantech.com.tw/rma>. If the web sever is shut down, please contact our office directly. You should fill in the "Problem Repair Form", describing in detail the application environment, configuration, and problems encountered. Note that error descriptions such as "does not work" and "failure" are so general that we are then required to apply our internal standard repair process.
4. Carefully pack the defective product, a completely filled-out Repair and Replacement Order Card and a photocopy of dated proof of purchase (such as your sales receipt) in a shippable container. A

product returned without dated proof of purchase is not eligible for warranty service.

5. Write the RMA number visibly on the outside of the package and ship it prepaid to your dealer.

Contents

Chapter 1 Overview	1
1.1 Introduction	2
1.2 Features	3
1.3 Specifications	4
1.4 Package Checklist	5
Chapter 2 Getting Started	7
2.1 Understanding the ADAM-4570/ADAM-4571/EDG-4504	9
2.1.1 Network Architecture	9
2.1.2 Top / Front / Rear View	11
2.1.2.1 ADAM-4570	11
2.1.2.2 ADAM-4571	13
2.1.2.3 EDG-4504	15
2.1.3 Stickers	17
2.2 Connecting the Hardware	18
2.2.1 Choosing a Location	18
2.2.1.1 ADAM-4570/4571	18
2.2.1.2 EDG-4504	22
2.2.2 Network Connection	23
2.2.3 Power Connection	24
2.2.4 Serial Connection	25
2.2.4.1 ADAM-4570/4571	25
2.2.4.2 EDG-4504	27
Chapter 3 Installation and Configuration	29
3.1 Driver and Utility Installation	30

3.2	Configuring the ADAM-4570/ADAM-4571/EDG-4504 — The Configuration Utility	31
3.2.1	Search for Specific ADAM-4570/ADAM-4571/EDG-4504	32
3.2.2	System Configuration	34
3.2.3	Network Configuration	36
3.2.4	Port Configuration	37
3.2.5	Security Configuration	39
3.3	Status Messages	40
3.3.1	Connection Diagnostic	40
3.4	Port Mapping Utility	42
3.4.1	Self Test Function	44
3.4.2	Upgrading ADAM-4570/ADAM-4571/EDG-4504's Firmware Download	46
3.4.3	Save The Configuration	49
	Chapter 4 Troubleshooting	51

Figures

Figure 2-1	Installation Flow Chart	8
Figure 2-2	Network Architecture(1)	10
Figure 2-3	Network Architecture(2)	10
Figure 2-4	ADAM-4570—Top Panel	12
Figure 2-5	ADAM-4570—Front Panel	12
Figure 2-6	ADAM-4570—Back Panel	12
Figure 2-7	ADAM-4571—Top Panel	14
Figure 2-8	ADAM-4571—Front Panel	14
Figure 2-9	ADAM-4571—Back Panel	14
Figure 2-10	EDG-4504—Top Panel	16
Figure 2-11	EDG-4504—Front Panel	16
Figure 2-12	EDG-4504—Front Panel	16
Figure 2-13	Panel Mounting	19
Figure 2-14	Din Rail Mounting	20
Figure 2-15	Piggyback Stack	21
Figure 2-16	Din Rail Mounting	22
Figure 2-17	Panel Mounting	22
Figure 2-18	Connecting ADAM-4570/ADAM-4571/EDG-4504 series to the hub	23
Figure 2-19	Power Connection for ADAM-4570/4571	24
Figure 2-20	Power Connection for EDG-4504	24
Figure 2-21	Serial Connection for ADAM-4570/4571	25
Figure 2-22	Serial Connection for EDG-4504	27
Figure 3-1	Configuration Utility	31
Figure 3-2	Locate all ADAM-4570/ADAM-4571/EDG-4504	32
Figure 3-3	Locate the desired group of ADAM-4570s	33
Figure 3-4	Locate specific ADAM-4570s	33
Figure 3-5	System Setting Window	34
Figure 3-6	Network Configuration Window	36
Figure 3-7	Port Configuration Window	37

Figure 3-8	Security configuration	39
Figure 3-9	Status messages	40
Figure 3-10	Unused ports	42
Figure 3-11	Assign COM port to ADAM-4570/ADAM-4571/EDG-4504	43
Figure 3-12	Warning window	43
Figure 3-13	Delete the COM port	44
Figure 3-14	Test window	45
Figure 3-15	Loopback test	46
Figure 3-16	Update firmware window	47
Figure 3-17	Select the file	47
Figure 3-18	Download firmware	48

Tables

Table 2-1	ADAM-4570 LED Definition	11
Table 2-2	ADAM-4571 LED Definition	13
Table 2-3	EDG-4504 LED Definition	15

Chapter 1
Overview

1.1 Introduction

The ADAM-4570/ADAM-4571/EDG-4504 is a lightning fast and cost effective data gateway between RS-232/422/485 and Ethernet interfaces. This unit immediately upgrades your existing device for integration into the Internet world. The ADAM-4570/ADAM-4571/EDG-4504 provides multiple RS-232/422/485 serial ports easily individually configured for your needs. And the transmission speed of the ADAM-4570/ADAM-4571/EDG-4504 is up to 230 Kbps, outstripping the competition to meet the demand for high-speed exchange. In addition, the user only needs the Windows utility to configure the ADAM-4570/ADAM-4571/EDG-4504 without the need for any other software. Functionally transparent and efficient, The ADAM-4570/ADAM-4571/EDG-4504 is specially designed for remotely controlling and monitoring devices via the Internet.

The ADAM-4570/ADAM-4571/EDG-4504 links both your *human-machine interface* (HMI) software and the existing RS-232/422/485 system architecture with an Ethernet network. Because the cabling of industrial automation is expensive, requires heavy maintenance and occupies massive amounts of room space, the ADAM-4570/ADAM-4571/EDG-4504 eliminates the amount of cabling. Using ADAM-4570/ADAM-4571/EDG-4504, you can save cabling space, and software development cost. The ADAM-4570/ADAM-4571/EDG-4504 also provides a high-performance RISC CPU and Real Time Operating System to reduce CPU load. This element makes the ADAM-4570/ADAM-4571/EDG-4504 more stable and reliable during data

transmission. Another benefit is the ADAM-4570/ADAM-4571/EDG-4504 allows users to remotely download programs to a designated device via Ethernet. This reduces the need for on-site maintenance and diagnosis.

In addition, The ADAM-4570/ADAM-4571/EDG-4504 comes with a Windows-based configuration and port-mapping utility. The configuration tool can auto-detect all ADAM-4570/ADAM-4571/EDG-4504s on the local network. It also lets you adjust all settings easily. The port mapping utility helps you to set up 255 ports for one Windows NT™ or Windows 2000 platform. This helps users manage all ports for their needs.

1.2 Features

- Expand up to 255 serial ports for one Windows NT and Windows 2000 host
- Supports 10/100 Base-T Ethernet standard
- Supports high transmission speeds up to 230 Kbps
- Supports LED indicators: Easy to diagnostic
- Auto-searching Windows configuration utility: Easy setting and security protection
- Port-mapping utility: Easy to manage 255 ports and self-diagnostic
- Easy to locate specific ADAM-4570/ADAM-4571/EDG-4504
- Supports real-time Operating System
- Surge protection for RS-485 line and power supply
- Mounts on DIN rail, panel or piggyback easily

1.3 Specifications

- Protocol: TCP/IP, UDP
- Network Port: IEEE 802.3, IEEE 802.3u
- Interface:
 - Network: 10/100 BASE-T standard
 - Serial: RS-232, RS-422, RS-485
- Port: 1/2/4 independent RS-232/422/485 ports
- Connector:
 - Network: RJ-45
 - Serial: RJ-48 (RJ-48 to DB-9 cable provided)
- Transmission speed: 300 bps to 230 Kbps
- Parity bit: odd, even, none, space, mark
- Data bit: 5, 6, 7, 8
- Stop bit: 1, 1.5, 2
- Signals: Full Modem control signals (Doesn't support RAS service)
- Diagnostic LEDs:
 - Network: TX/RX, Link, Speed (10/100 Mbps), Power
 - Serial: TX/RX, Status
- Utility Software:
 - Auto-detecting configuration utility
 - Easy-to-manage port mapping utility
- Driver Supported:
 - Windows NT 4.0 & Windows 2000 driver
- Power Requirements: unregulated 10 to 30 Vdc with surge protection

- Power Consumption:
3.5 Watt (ADAM-4571)
4 Watt (ADAM-4570)
4.5 Watt (EDG-4504)
- Placement:
DIN-rail, panel mounting, piggyback stack
(ADAM-4570/4571)
DIN-rail, panel mounting (EDG-4504)
- Operating Temperature: 0 ~ 60° C
- Storage Temperature: -20 ~ 80° C
- Operating Humidity: 20 ~ 95% (non-condensing)
- Storage Humidity: 0 ~ 95% (non-condensing)

1.4 Package Checklist

- ADAM-4570 or ADAM-4571 or EDG-4504
- User's Manual
- Windows Configuration utility disk
- Driver/Port Mapping utility disk
- 1/2/4 RJ-48 to DB-9 serial cables
- One loopback DB-9 tester
- Five stickers
- NYLON DIN-rail Mounting Adapter
- SECC Panel Mounting Bracket

Chapter
2
Getting Started

In this chapter, you will be given an overview of the ADAM-4570/ADAM-4571/EDG-4504 hardware installation procedures. As mentioned in the previous chapter, the ADAM-4570/ADAM-4571/EDG-4504 comes ready for all network connections, including Ethernet, and RS-232/422/485 port connections.

We begin this chapter with a brief showing the installation procedure. You can take flow chart for reference.

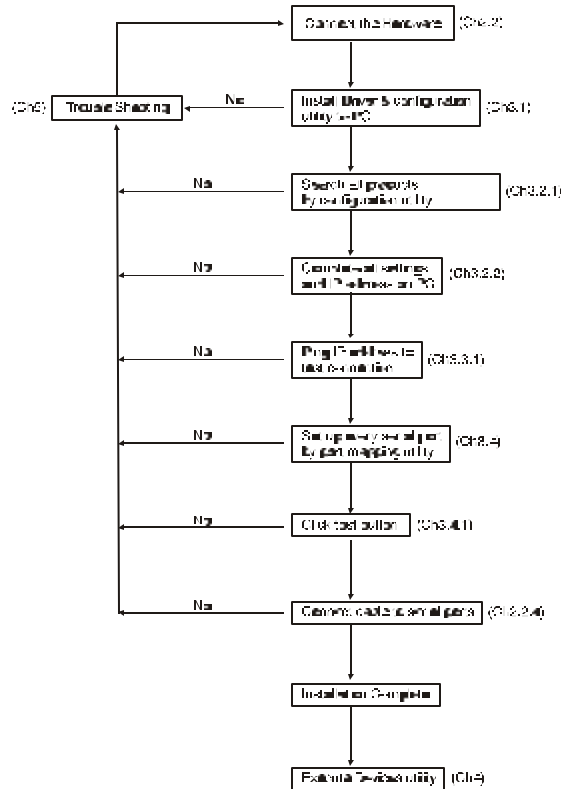

Figure2-1 Installation Flow Chart

2.1 Understanding the ADAM-4570/ADAM-4571/EDG-4504

The ADAM-4570/ADAM-4571/EDG-4504 is an advanced data gateway unit. It extends traditional COM ports of a PC with access over a TCP/IP network. Through networking, you can control and monitor remote serial devices either over a LAN or over the WAN.

Since the ADAM-4570/ADAM-4571/EDG-4504 is connected through a TCPIP network, you will need to know some basic facts about networking in order to get the server hooked up correctly.

2.1.1 Network Architecture

Traditional serial port communication uses a COM port board that slides into one of the slots at the back of your PC. In this case, only the computer containing the board can access the serial port. With the ADAM-4570/ADAM-4571/EDG-4504, you are now able to access the COM port from a distance through local area network. The ADAM-4570/ADAM-4571/EDG-4504 can be integrated within the network architecture of any protocol. Note, all serial devices which are connected to the port must have the same protocol running and the same transmission speed. Connect devices running different protocols to different ports of the ADAM-4570/ADAM-4571/EDG-4504.

The following illustration shows the network architecture as below:

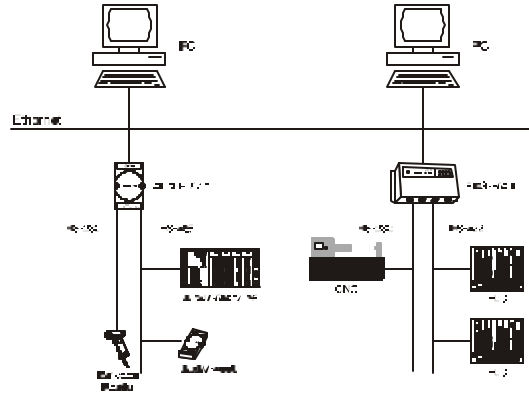

Figure 2-2 Network Architecture(1)

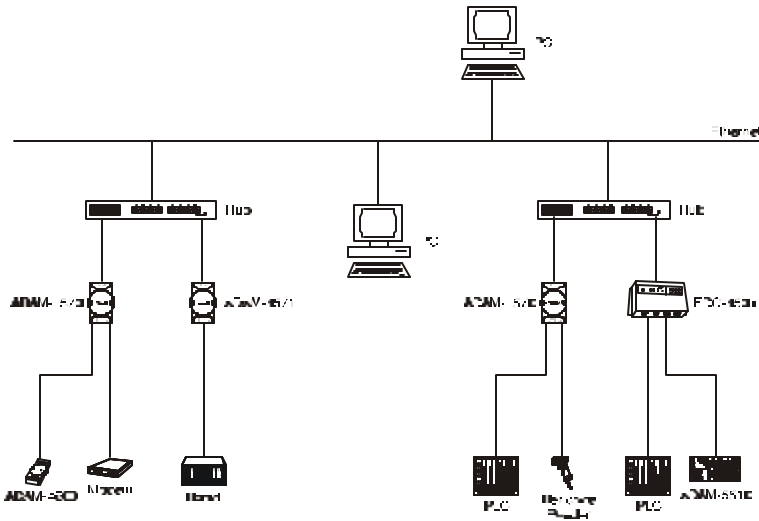

Figure 2-3 Network Architecture(2)

2.1.2 Top / Front / Rear View

2.1.2.1 ADAM-4570

There are five network status LEDs located on the top panel of ADAM-4570, each with its own specific function.

LED	Color	Status	Description
Status/Power	Red	ON	Heartbeat (1 time/sec)
		OFF	Not working
	Green	ON	Power ON
		OFF	Power OFF
Speed/Link	Red	ON	100 Mbps speed
		OFF	10 Mbps speed
	Green	ON	Valid network link
		OFF	Invalid network link
Tx/Rx (Ethernet)	Red	ON	Ethernet data being transmitted
		OFF	No data being transmitted
	Green	ON	Data being received
		OFF	No Data being received
Tx/Rx (port1)	Red	ON	Serial port data being transmitted
		OFF	No data being received
	Green	ON	Data being received
		OFF	No data being received
Tx/Rx (port2)	Red	ON	Data being transmitted
		OFF	No data being transmitted
	Green	ON	Data being received
		OFF	No data being received

Table 2-1 ADAM-4570 LED Definition

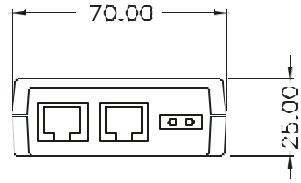

Figure 2-4 ADAM-4570—Top Panel

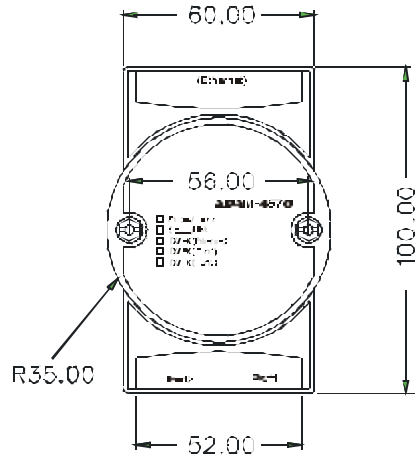

Figure 2-5 ADAM-4570—Front Panel

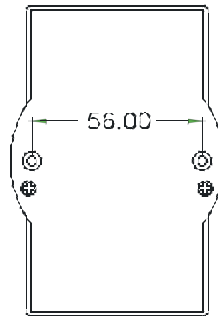

Figure 2-6 ADAM-4570—Back Panel

2.1.2.2 ADAM-4571

There are four LEDs located on the top panel of ADAM-4571, each with its own specific function.

LED	Color	Status	Description
Status/Power	Red	ON	Heartbeat (1 time/sec)
		OFF	Not working
	Green	ON	Power ON
		OFF	Power OFF
Speed/Link	Red	ON	100 Mbps speed
		OFF	10 Mbps speed
	Green	ON	Valid network link
		OFF	Invalid network link
Tx/Rx (Ethernet)	Red	ON	Ethernet data being transmitted
		OFF	No data being transmitted
	Green	ON	Data being received
		OFF	No Data being received
Tx/Rx (port1)	Red	ON	Data being transmitted
		OFF	No data being transmitted
	Green	ON	Data being received
		OFF	No data being received

Table 2-2 ADAM-4571 LED Definition

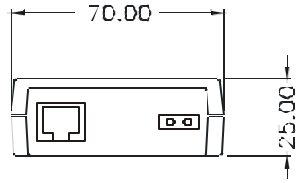

Figure 2-7 ADAM-4571—Top Panel

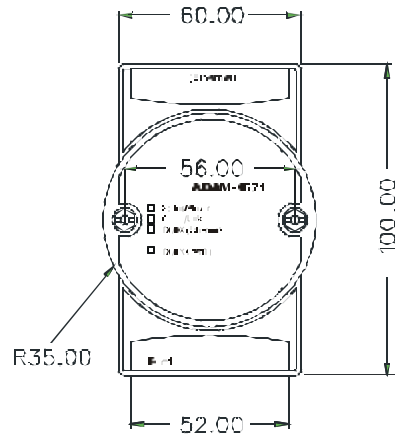

Figure 2-8 ADAM-4571—Front Panel

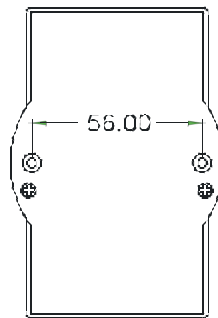

Figure 2-9 ADAM-4571—Back Panel

2.1.2.3 EDG-4504

There are 13 LEDs located on the top panel of EDG-4504, each with its own specific function.

LED	Status	Description
Status	ON	Heart beat (1 time/sec)
	OFF	Not working
10M	ON	10 Mbps speed
	OFF	Invalid 10 Mbps Network link
100M	ON	100 Mbps speed
	OFF	Invalid 100 Mbps Network link
TX (Ethernet)	ON	Ethernet data being received
	OFF	No data being transmitted
RX (Ethernet)	ON	Ethernet data being received
	OFF	No data being received
TX (port N) N=1~4	ON	Serial port data being transmitted
	OFF	No data being received
RX (port N) N=1~4	ON	Serial port data being transmitted
	OFF	No data being received

Table 2-3 EDG-4504 LED Definition

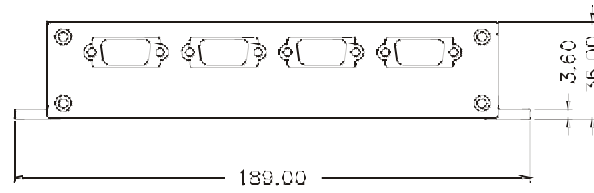

Figure 2-10 EDG-4504—Top Panel

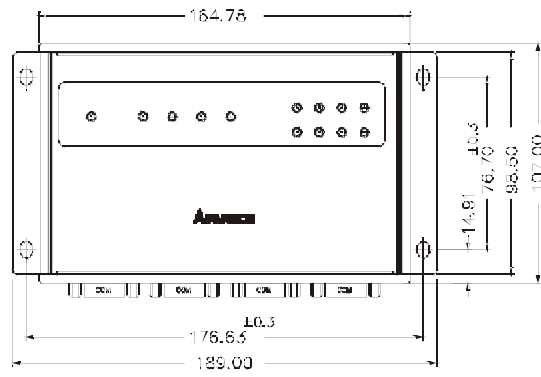

Figure 2-11 EDG-4504—Front Panel



Figure 2-12 EDG-4504—Front Panel

2.1.3 Stickers

If you forgot the IP addresses of specific ADAM-4570/ADAM-4571/EDG-4504s or where the host PC is mapped to the ADAM-4570 port, we have provided five stickers for you to note the IP addresses and place in a secure location. For example,

172.20.20.5: The IP address of specific ADAM-4570

160.59.20.89: The IP address of the specific host PC mapped to this port.

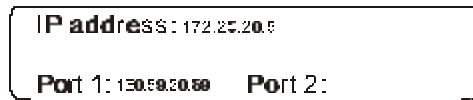

2.2 Connecting the Hardware

Next, we will explain how to find a proper location for your EDG COMPort series, and then explain how to connect to the network, hook up the power cable, and connect to the ADAM-4570/ADAM-4571/EDG-4504's serial port.

Note: Before you install ADAM-4570/ADAM-4571/EDG-4504, you can install other communication cards first.

2.2.1 Choosing a Location

2.2.1.1 ADAM-4570/4571

Due to its versatility and innovative design, the ADAM-4570/ADAM-4571 can be:

- fixed to a panel mount
- fixed to a DIN Rail.
- Piggyback Stack

Panel Mounting

The ADAM-4570/ADAM-4571 can be attached to a wall using the included metal brackets. Each bracket comes with four screws; first attach the brackets to the bottom of the ADAM-4570/ADAM-4571. Next, screw each bracket to a wall.

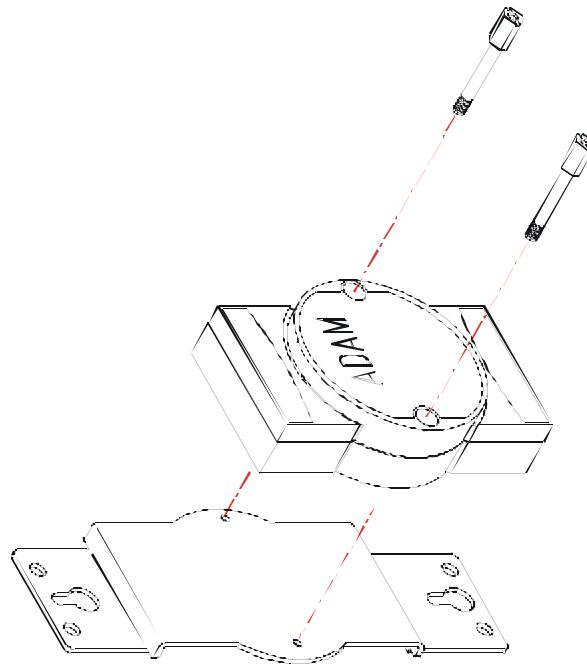

Figure 2-13 Panel Mounting

DIN Rail Mounting

You can mount the ADAM-4570/ADAM-4571 on a standard DIN Rail. First, using two screws, attach the metal plate to the DIN Rail bracket. Because the screw heads are beveled, the tops of the screws will be flush with the metal plate. Din Rail Mounting Brackets—Orientation of Metal Plates

You can now screw the metal plate with the DIN rail bracket assembly to the bottom of the server in a more convenient way. Next, use the remaining screws to put the metal plate on the bottom of the ADAM-4570/ADAM-4571.

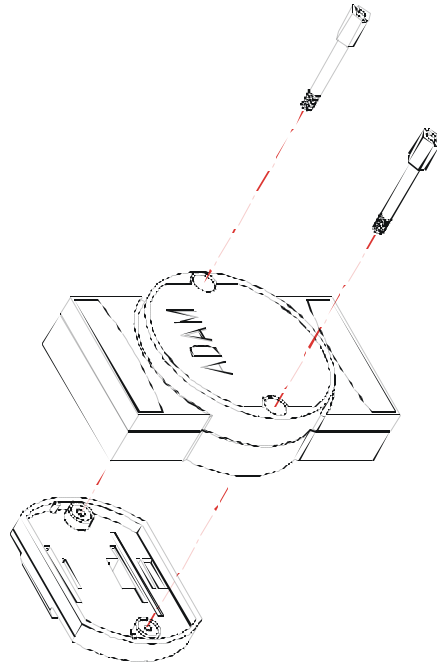

Figure 2-14 Din Rail Mounting

Piggyback Stack

ADAM-4570/ADAM-4571 can be stacked as seen in the figure below.

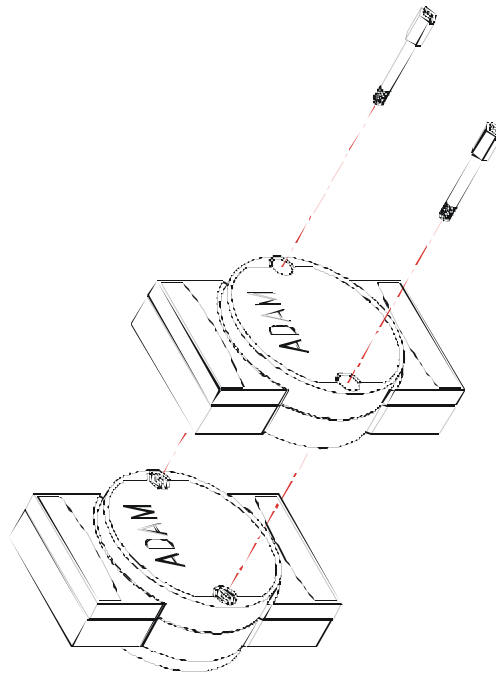

Figure2-15 Piggyback Stack

2.2.1.2 EDG-4504

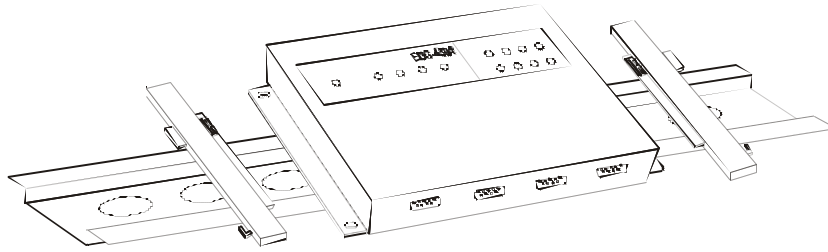

Figure 2-16 Din Rail Mounting

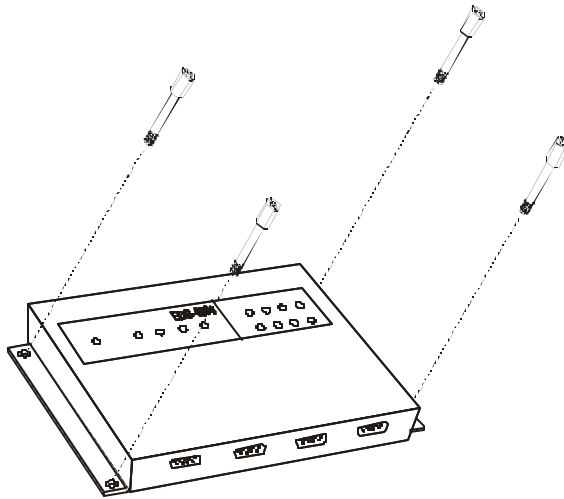

Figure 2-17 Panel Mounting

2.2.2 Network Connection

There are two ways to use the 10/100Base-T Ethernet connector located on the ADAM-4570/ADAM-4571/EDG-4504 :

1. For Local Area Network (LAN) applications using the ADAM-4570/ADAM-4571/EDG-4504, you will simply plug one end of your Ethernet cable into the 10/100Base-T connector, and the other end into the hub connected to your network.
2. When installing and configuring, you will find it convenient to hook the ADAM-4570/ADAM-4571/EDG-4504 directly to your computer's Ethernet card. To do this you will need to use a "crossed-cable", such as the one supplied with your server.

Cabling requirements for the Ethernet side

Use an RJ-45 connector to connect the Ethernet port of the ADAM-4570/ADAM-4571/EDG-4504 to the network hub. The cable for connection should be Category 3 (for 10Mbps data rate) or Category 5 (for 100 Mbps data rate) UTP/STP cable, which is compliant with EIA/TIA 586 specifications. Maximum length between the hub and any ADAM-4570/ADAM-4571/EDG-4504 is up to 100 meters (ca. 300 ft).



Figure 2-18 Connecting ADAM-4570/ADAM-4571/EDG-4504 series to the hub

2.2.3 Power Connection

You should take the following steps to connect ADAM-4570/ADAM-4571/EDG-4504 power.

1. Connect the power cable to 2-pin connector
2. Connect power cable to power adapter

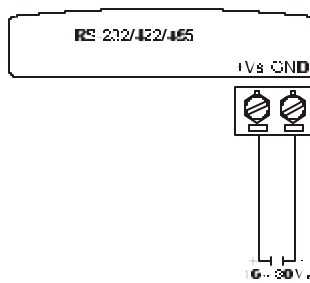

Figure 2-19 Power Connection for ADAM-4570/4571

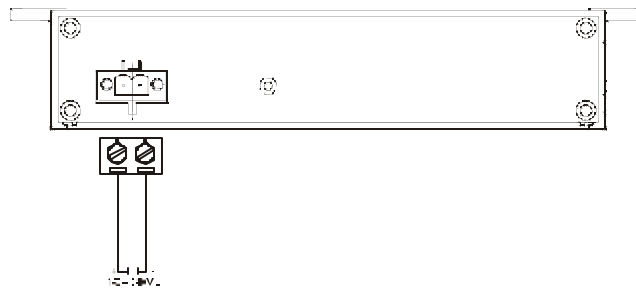

Figure 2-20 Power Connection for EDG-4504

If the ADAM-4570/ADAM-4571/EDG-4504 is working properly, the green power LED will light up, indicating that the ADAM-4570/ADAM-4571/EDG-4504 is receiving power. Furthermore, the ADAM-4570/ADAM-4571/EDG-4504 provides surge protection to protect it from being damaged by over-voltage, a 34V surge protection is added to the power end and an 18V surge protection is for the RS-422/485 end.

2.2.4 Serial Connection

2.2.4.1 ADAM-4570/4571

The model of the ADAM-4570/4571 that you purchased has RJ-48 serial ports on the bottom of module. Depending on your serial device and serial interfaces, there are two options:

1. For an RS-232/422/485 port you may use a RJ-48 to DB-9 cable which we supply to connect your serial device to the ADAM-4570/4571. Simply plug one end of the cable into the jack, and plug the other end into the serial port jack on your serial device.
2. Refer to the following table for details on serial cable RJ-48 to DB-9 pinouts.

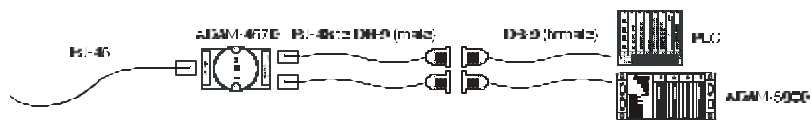
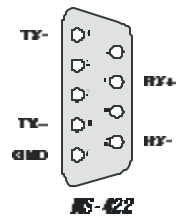
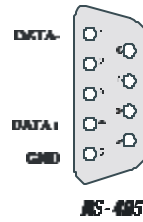
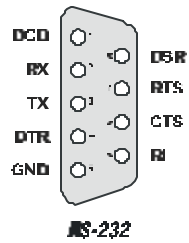

Figure 2-21 Serial Connection for ADAM-4570/4571

RJ-48

PIN Name	DCD	RX	TX	DTR	GND	DSR	RTS	CTS	RI
RJ-48	1	2	3	4	5	6	7	8	9

DB-9



2.2.4.2 EDG-4504

The model of the EDG-4504 that you purchased has DB-9 serial ports on the bottom of module. Depending on your serial device and serial interfaces, there are two options:

1. For an RS-232/422/485 port you may use a DB-9 cable to connect your serial device to the EDG-4504. Simply plug one end of the cable into the jack, and plug the other end into the serial port jack on your serial device.
2. The DB-9 pinouts is the same as ADAM-4570/4571

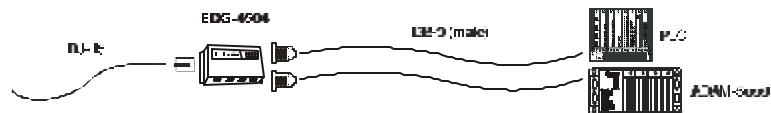

Figure 2-22 Serial Connection for EDG-4504

Chapter 3

Installation and Configuration

3.1 Driver and Utility Installation

In order to use a PC via an Ethernet network to control serial devices connected to the ADAM-4570/ADAM-4571/EDG-4504, you must first have a host running Windows™ NT4.0 or Windows 2000. This type of application also requires the host to have an Ethernet card and TCP/IP protocol installed. Following are the installation instructions to set up the ADAM-4570/ADAM-4571/EDG-4504.

1. Insert the ADAM-4570/ADAM-4571/EDG-4504 Driver/Port Mapping utility diskette into the floppy drive (e.g. A:) on the host PC. Change the host computer's default drive from C: to A:
2. Use your Windows Explorer or the Windows Run command to execute the Setup program (the path for the Setup program on the diskette should be A:\setup.exe, if your default floppy drive is A:).
3. The Setup program will specify a default installation path, *C:\Program Files\Advantech\EDG COMport\1, 2 and 4 ports Mapping utility*. If a new destination path is necessary, just click the *Browse* button to change to another path. After you have specified the installation path, click the *Next* button.
4. Insert the ADAM-4570/ADAM-4571/EDG-4504 Configuration utility diskette into the floppy drive (e.g. A:). Use the same way to execute the Setup program. The default path is *C:\Program Files\Advantech\EDG COMport\1, 2 and 4 Configuration utility*.
5. After setup has copied all program files to your computer, click the *Finish* button to finish the installation.

6. The configuration utility will search for the ADAM-4570/ADAM-4571/EDG-4504 devices on your local network.

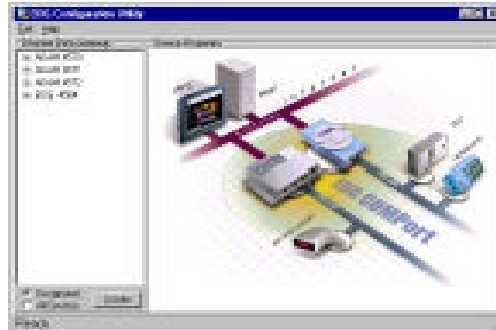
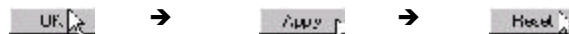

Figure 3-1 Configuration Utility

3.2 Configuring the ADAM-4570/ADAM-4571/EDG-4504 — The Configuration Utility

The ADAM-4570/ADAM-4571/EDG-4504 provides easy Windows configuration through Ethernet connection. This Windows utility searches all the ADAM-4570/ADAM-4571/EDG-4504 and devices on the network automatically and you can configure various parameters for TCP/IP configuration easily. For secure administration, it can also restrict the access rights for configuration to only one host PC to enhance network security. With this secure function enabled, other PCs will not have permission for configuration. The Windows utility consists of four functional categories: System, Network, Port, and Security which are presented on the toolbar of the configuration utility.

Note: When you have finished the configuration of these settings for each category, please follow the steps described below to make these settings effective on the ADAM-4570/ADAM-4571/EDG-4504.



3.2.1 Search for Specific ADAM-4570/ADAM-4571/ EDG-4504

If you want to locate specific ADAM-4570/ADAM-4571/EDG-4504s, the configuration utility provides a “Locate” function to assist you. You can select all the ADAM-4570/ADAM-4571/EDG-4504 devices (see Figure 3-2) or select a group of ADAM-4570s (see Figure 3-3) or just select one ADAM-4570 (see Figure 3-4). When you select a specific device, the LED that stands for “Status” will glow for 8 minutes. When you select another device, the original “Status” LED will turn off. Please follow these steps:

1. Select “All Devices” and click “Locate”
2. The “Status” LED of all devices will turn on

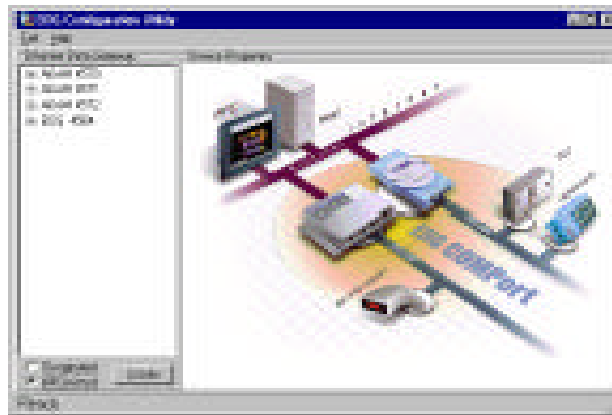

Figure 3-2 Locate all ADAM-4570/ADAM-4571/EDG-4504

1. Select “Designated” and select “ADAM-4570”
2. Click “Locate”

3. The “Status” LED of all ADAM-4570s on the LAN will turn on
4. It’s the same way to locate one device.



Figure 3-3 Locate the desired group of ADAM-4570s

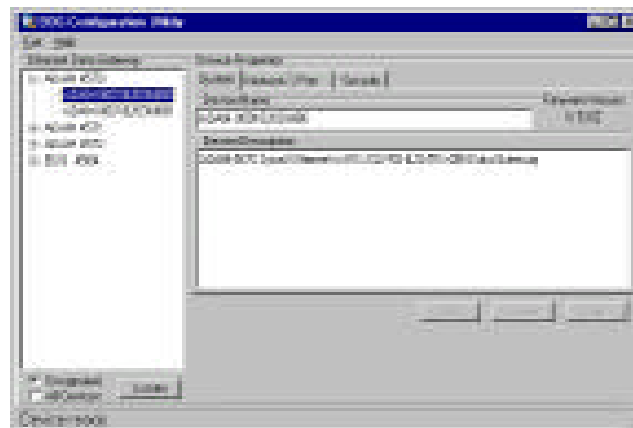

Figure 3-4 Locate specific ADAM-4570s

3.2.2 System Configuration

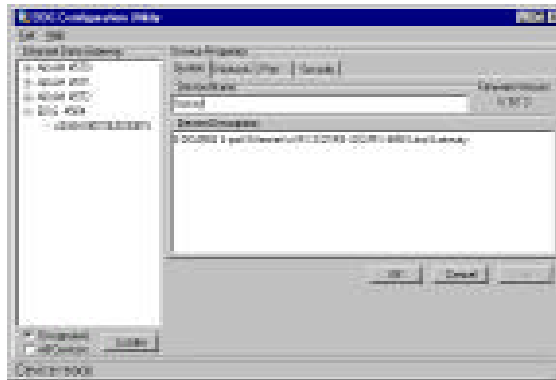

Figure 3-5 System Setting Window

Configuration utility can only search the ADAM-4570/ADAM-4571/EDG-4504 devices on the local network segment and *cannot search beyond a router or gateway*. Make sure that all the ADAM-4570/ADAM-4571/EDG-4504 devices that you want to monitor must reside on the same local network segment with the host PC.

Ethernet Data Gateway

In this column, you will see all the found ADAM-4570/ADAM-4571/EDG-4504 devices are listed when you use the configuration utility to auto-search ADAM-4570/ADAM-4571/EDG-4504 devices. The specific number following each ADAM-4570/ADAM-4571/EDG-4504 device is its MAC Address. The MAC Address is what helps the local system to identify and locate each Ethernet data gateway device. This MAC Address is already set before delivery from factory, hence no need for further configuration.

Device Name

Configuration utility provides a default name for device to distinguish a specific ADAM-4570/ADAM-4571/EDG-4504 from other ADAM-4570/ADAM-4571/EDG-4504. You can update the default device name based on your application. Names longer than 128 characters cannot be used. It is best to choose a name you can remember.

Device Description

This field is to record the function, application and other information for each ADAM-4570/ADAM-4571/EDG-4504 device in more detail for easy management and maintenance. You are allowed to describe in your own words.

Firmware version

In this field, the configuration utility represents the firmware version of the ADAM-4570/ADAM-4571/EDG-4504. You might need to refer to the firmware version to determine functions available on the ADAM-4570/ADAM-4571/EDG-4504 device. In case of problems that might concern the firmware version, please provide the firmware version number to our Customer Service.

Type

Each ADAM-4570/ADAM-4571/EDG-4504 offers three serial interfaces, RS-232, RS-485 and RS-422. You can use any one of these serial interfaces according to your requirements.

3.2.3 Network Configuration

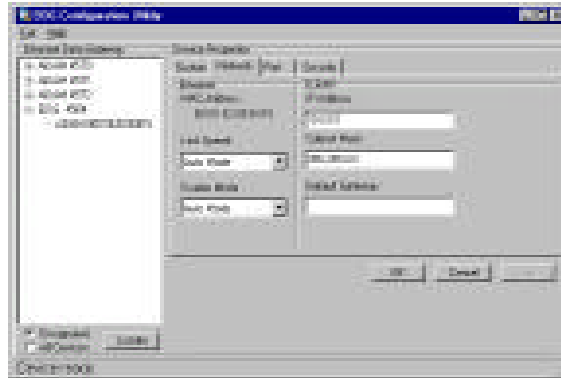

Figure 3-6 Network Configuration Window

MAC Address

This does not need configuration.

Link Speed

This function will show the current linking speed to be either 10Mbps or 100Mbps. However, the utility will auto-detect the current transmission speed on the network segment and set the transmission speed for the device accordingly without your further efforts.

Duplex Mode

The utility will detect the current transmission mode (half-duplex or full-duplex) on the network segment, and set the transmission mode for the device accordingly without your further efforts.

IP address, Subnet Mask, Default Gateway

The IP address identifies your ADAM-4570/ADAM-4571/EDG-4504 device on the global network. Each ADAM-4570/ADAM-4571/EDG-4504 has same default IP address 10.0.0.1. Obtain a specific IP address from your network administrator and then configure each ADAM-4570/ADAM-4571/EDG-4504 with the individual IP address.

Note: The ADAM-4570/ADAM-4571/EDG-4504 does not support auto IP address configured by DHCP server.

3.2.4 Port Configuration

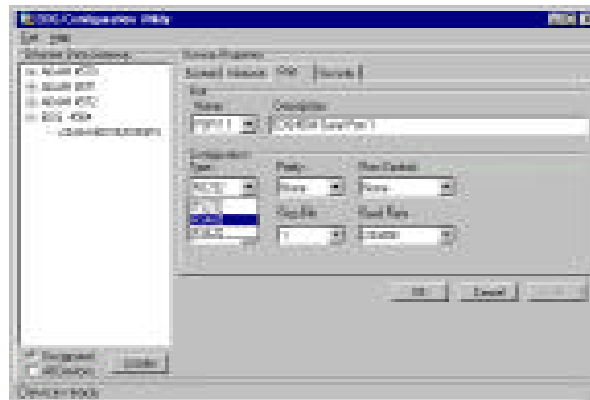

Figure 3-7 Port Configuration Window

Name

To specify which port on the ADAM-4570/ADAM-4571/EDG-4504 is to be connected to the serial device.

Description

You can give more detailed description of the function of the port for easy management and maintenance. Descriptions longer than 128 characters cannot be used.

Type

Each ADAM-4570/ADAM-4571/EDG-4504 offers three kinds of serial interfaces, RS-232, RS-485 and RS-422. You can use any of the three serial interfaces according to your requirements.

Parity

The ADAM-4570/ADAM-4571/EDG-4504 provides five options: Even, Odd, None, Space, Mark.

Flow Control

The ADAM-4570/ADAM-4571/EDG-4504 provides four options: None, Xon/Xoff, RTS/CTS, DTR/DSR.

Data Bits

The ADAM-4570/ADAM-4571/EDG-4504 provides four options: 5, 6, 7 or 8.

Stop Bits

The ADAM-4570/ADAM-4571/EDG-4504 provides three options: 1, 1.5 or 2.

Baud Rate

The ADAM-4570/ADAM-4571/EDG-4504 supports baud rates from 300 to 230,000 bps.

3.2.5 Security Configuration

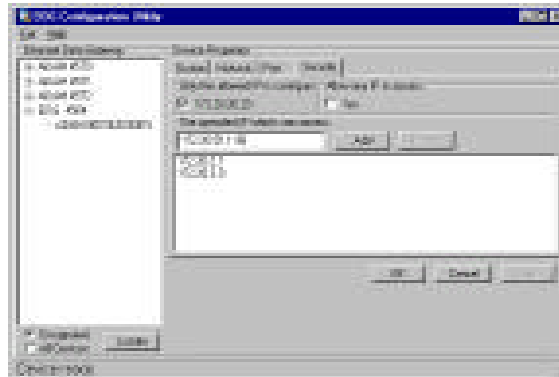

Figure 3-8 Security configuration

Only configure the authorized IP

This option is enabled in order to protect all configuration settings from being changed inadvertently.

Allow any IP to access

If this option is enabled, any PC can access data from this ADAM-4570/ADAM-4571/EDG-4504.

The specified IP which can access

If you do not want many PCs to have the access right, you can limit at most 32 PCs to access data from this ADAM-4570/ADAM-4571/EDG-4504.

3.3 Status Messages

The status message shown at the bottom of the utility window reflects the current status of ADAM-4570/ADAM-4571/EDG-4504.

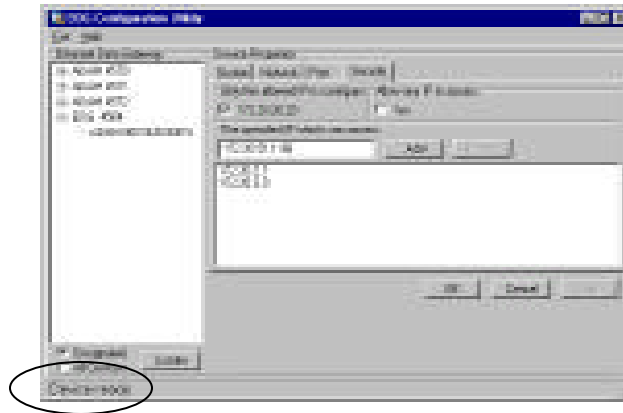

Figure 3-9 Status messages

“Read”

The configuration utility has found the ADAM-4570/ADAM-4571/EDG-4504 and it is ready for use.

“Searching EDG COMport”

The configuration utility is searching the ADAM-4570/ADAM-4571/EDG-4504

“Querying DATA from EDG COMport”

The configuration utility is getting data from the ADAM-4570/ADAM-4571/EDG-4504.

“Device Ready”

The ADAM-4570/ADAM-4571/EDG-4504 is ready to be configured and is now waiting for acknowledgement from the device.

“Lost Connection from the Device”

Due to device shut down or network failure, the configuration utility has lost connection after 5 seconds.

“Fail to apply this setting to the device”

Specific settings are not accepted by ADAM-4570/ADAM-4571/EDG-4504.

“The device fails to respond”

The connected device does not respond.

“Fail to reset the device”

Fail to reset the ADAM-4570/ADAM-4571/EDG-4504.

3.3.1 Connection Diagnostic

When you complete the configuration of your ADAM-4570/ADAM-4571/EDG-4504s, you can follow the steps to check if the ADAM-4570/ADAM-4571/EDG-4504 connects to network or not.

1. Execute the Microsoft DOS program.
2. Execute ***“PING”*** command and type your IP address of ADAM-4570/ADAM-4571/EDG-4504. If ADAM-4570/ADAM-4571/EDG-4504 connects to your network, it will display in the screen. If the ADAM-4570/ADAM-4571/EDG-4504 cannot be pinged, you will need to ask someone

at the remote site to check and see if the power is on, and make sure that the connection is okay.

3.4 Port Mapping Utility

The purpose of the port mapping utility is to help you manage all ports which are in one Windows NT or Windows 2000 platform. The utility displays three types of ports: *Used ports*, *Unused ports* and *ADAM-4570/ADAM-4571/EDG-4504 ports*. Please follow the steps.

1. Click the UNUSED PORTS item and select the port which you want to configure.

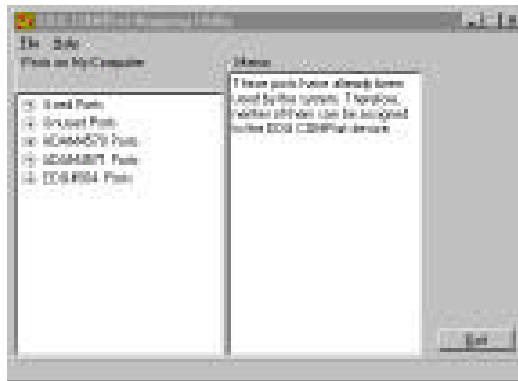

Figure 3-10 Unused ports

2. Click **ADD** button to assign the COMport to the specific ADAM-4570/ADAM-4571/EDG-4504.
3. Type IP address of the ADAM-4570/ADAM-4571/EDG-4504 and select ports.

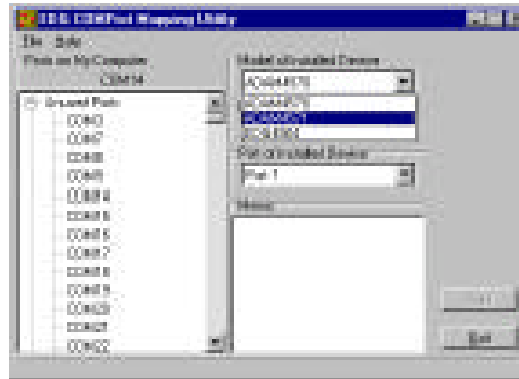

Figure 3-11 Assign COM port to ADAM-4570/ADAM-4571/EDG-4504

Note: If you assigned different COMport to the same ADAM-4570's port. The dialog box will appear to remind you.



Figure 3-12 Warning window

4. The port has been added into ADAM-4570/ADAM-4571/EDG-4504
5. If you want to remove the COMport, click **DELETE** to remove this.

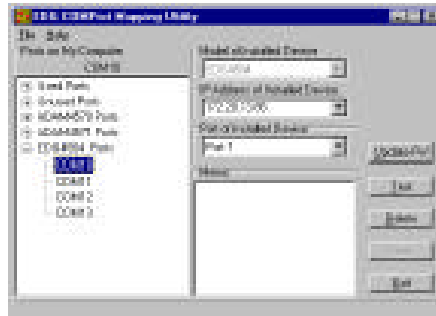

Figure 3-13 Delete the COM port

6. After you complete the configuration, click "Apply".

3.4.1 Self Test Function

The purpose of this test is to make sure the communication from host PC to ADAM -4570 is OK. If there is still an error, you can check the communication from the ADAM-4570/ADAM-4571/EDG-4504 to the serial devices.

If the test is selected, an external test will be done to check that the connection signals for each port are working properly. For the test, you will need to connect each port to a loopback tester (provided in the package). Refer to the following chart for the specifications of this loopback tester. The loopback test only applies to RS-232 mode. The test is divided into two parts: Signal test and Communication Parameters test.

1. Click the Test button in the Port Mapping utility.

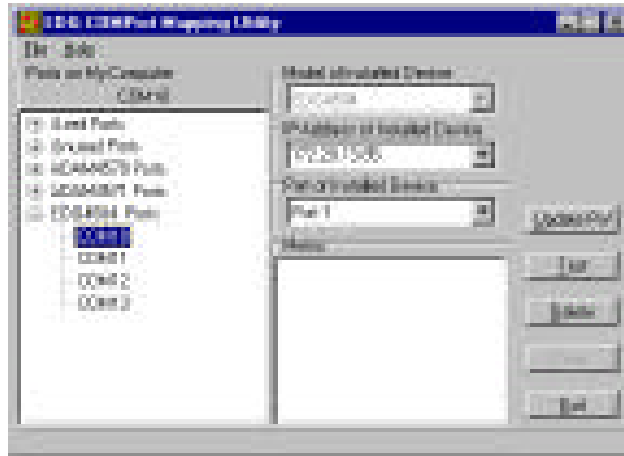

Figure 3-14 Test window

Signal Test

- **RTS → CTS:** Check the RTS and CTS signals between two ports.
- **DTR → RI:** Check the DTR and RI signal between two ports.
- **DTR → DSR:** Check the DTR and DSR signal between two ports.
- **DTR → DCD:** Check the DTR and DCD signal between two ports.

Communication Parameters Test

- Baud rate: From 50 bps to 230 Kbps
- Data bit: 5,6, 7, 8
- Stop bit: 1, 1.5, 2
- Parity: odd, even, none, space, mark

2. Click **OK** button to return to the port mapping window. All the ports in the ADAM-4570/ADAM-4571/EDG-4504 are tested ok.

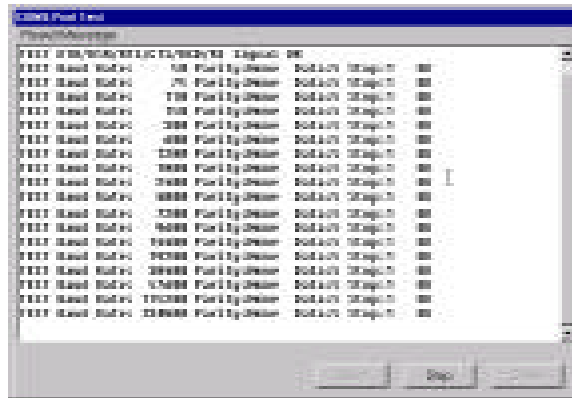

Figure 3-15 Loopback test

3.4.2 Upgrading ADAM-4570/ADAM-4571/EDG-4504's Firmware Download

Advantech continually upgrades its firmware to keep pace with the ever-expanding world of computing. You can use the Download function located on Port Mapping utility to carry out the upgrade procedure. Please access Advantech's Web site at <http://www.advantech.com> to download the required computer file and then follow these instructions.

1. Click on the toolbar **Update FW** icon.

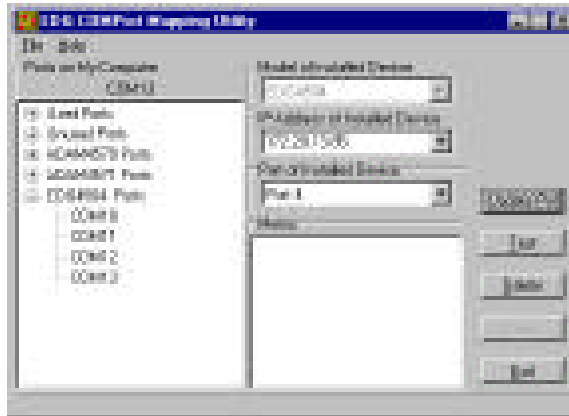

Figure 3-16 Update firmware window

2. Locate and then select the filename of the firmware that you downloaded.

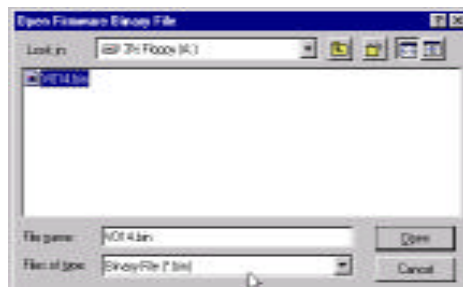

Figure 3-17 Select the file

3. After downloading firmware completely, click on the **Reboot** button. The ADAM-4570/ADAM-4571/EDG-4504 will restart automatically.

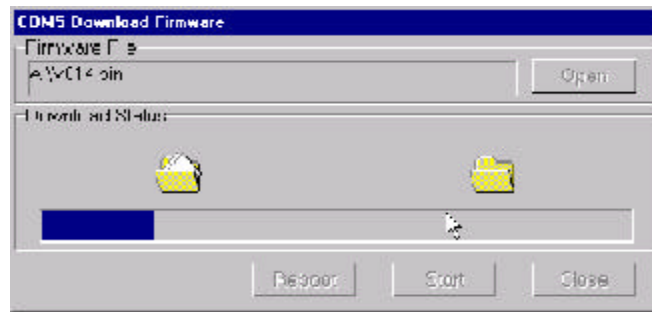

Figure 3-18 Download firmware

Note: After clicking **Reboot** button, configuration utility will not reboot ADAM-4570/ADAM-4571/EDG-4504 until no application program access this ADAM-4570/ADAM-4571/EDG-4504.

3.4.3 Save The Configuration

If you want to save or recover the configuration, you can select the “Import/Export” items.

1. a. Select “File”
- b. Select “Import” or “Export”

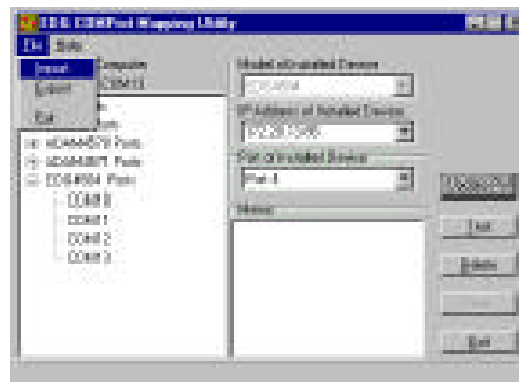

2. Save or open the configurations

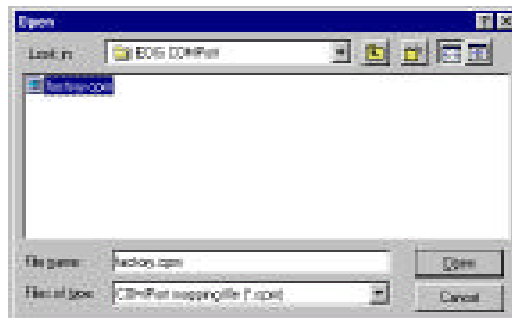

Chapter 4
Troubleshooting

This chapter explains how to solve some of the most common problems you could encounter while using ADAM-4570/ADAM-4571/EDG-4504. If you are still having problems after reading this chapter, contact your dealer, or e-mail Advantech for help.

“Configuration Utility can not find ADAM-4570/ADAM-4571/EDG-4504”

1. Check POWER LED. If it is off, you have to check :
 - Make sure the ADAM-4570/ADAM-4571/EDG-4504 power cable is plugged in, and the server is receiving power.
 - Check that the server’s network connector is plugged in properly.
 - Make sure your computer is properly connected to the network.
 - The input voltage is between +10V and +30V
2. Check LINK LED. If it is off, you have to check:
 - Network Connection is OK
 - Make sure your network is 10/100 Mbps
3. Check Driver Installation. Make sure that your O.S. is Windows NT 4.0 (Serve Pack 3.0 or above) or Windows 2000.

4. If the above are completed, it means the ADAM-4570/ADAM-4571/EDG-4504 is okay. Next, check to see if the ADAM-4570/ADAM-4571/EDG-4504 and the host are on the same local area network.

“Configuration utility can find ADAM-4570/ADAM-4571/EDG-4504 but cannot access ADAM-4570/ADAM-4571/EDG-4504”

For security reasons, and to simplify operations, users can give the access right to specific PC. Only these PCs can get data from ADAM-4570/ADAM-4571/EDG-4504. Thus, if while using the ADAM-4570/ADAM-4571/EDG-4504, it is advised that you check to see if your PC is on the access right list.

“Cannot change the IP address or other server properties”

The network administrator is the only one allowed to modify the ADAM-4570/ADAM-4571/EDG-4504’s configuration. Keep in mind, even when multiple hosts share the same network, administrative access is still protected. If you need to change any configuration settings, ask your network administrator for assistance.

“The host PC can access the ADAM-4570/ADAM-4571/EDG-4504 at this local site but later moves the ADAM-4570/ADAM-4571/EDG-4504 to a remote site that PC cannot access.”

Due differing network interface connections, your IP address might have changed, and as a result, you are no longer on the ADAM-4570/ADAM-4571/EDG-4504’s Access Control list.

To resolve this issue:

1. Confirm your IP address with the ADAM-4570/ADAM-4571/EDG-4504.
2. As the network administrator to set up the server configuration so that you are on the ADAM-4570/ADAM-4571/EDG-4504’s Access Control list.